



TNC 620

Compact Contouring Control for Milling, Drilling and Boring Machines

www.heidenhain.com/cnc-controls

Contents



TNC 620 with 19-inch touchscreen (portrait)

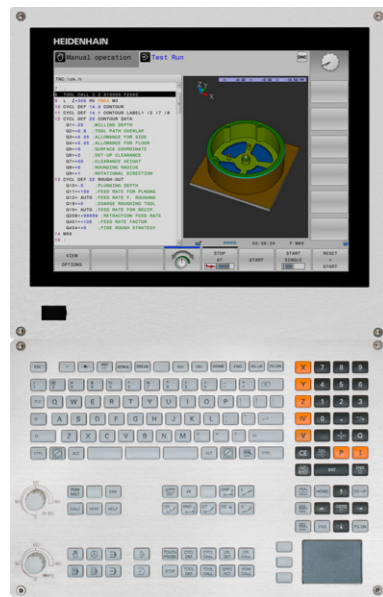

TNC 620 with 15-inch touchscreen



The functions and specifications described in this brochure apply to the TNC 620 with NC SW 81760x-18

The TNC 620...

Where can it be used?	Compact and versatile The right control for milling, drilling and boring machines	4
What does it look like?	Intuitive and user-friendly State-of-the-art multitouch operation Highly practical user interface	6
What can it do?	Fast and reliable machining at high contour fidelity Optimal tool guidance by the TNC 620	10
	Machining with five axes TNC 620-controlled swivel head and rotary table	12
	Minimize setup times The TNC 620 makes setup easy	14
	Automated machining The TNC 620 measures, manages and communicates Monitoring functions, pallet management and multiple machining	16
	How is it programmed?	Programming, editing and testing A full range of possibilities with the TNC 620 Graphical support in any scenario
Which accessories are available?	Programming on the shop floor Straightforward function keys for complex contours Programming free contours and Data Matrix codes Practical cycles for recurring operations Reusing programmed contour elements Rapid availability of all information	20
	Intelligent machining Dynamic Precision Active chatter control (ACC, option) Optimized roughing processes with OCM (option)	26
	Open to outside information StateMonitor: collect and evaluate machine data Fully digital job management with Connected Machining Processing CAD files with the TNC 620 The TNC 620 programming station	31
Which accessories are available?	Positioning with an electronic handwheel Fine motion control of axes	37
	Workpiece measurement Setup, preset setting, and measuring with touch trigger probes	38
	Tool measurement Measuring length, radius, and wear inside the machine	39
	Inspecting and optimizing machine accuracy Easy calibration of rotary axes with KinematicsOpt (option)	40
... At a glance	Overview User functions, accessories, software options, specifications, comparison of controls	41

Compact and versatile

The right control for milling, drilling and boring machines

For more than 45 years, TNC controls from HEIDENHAIN have proven themselves every day on milling machines, machining centers, and drilling machines. Over this period, they have been continually further developed, with focus placed on an operating approach tailored to the needs of the TNC 620 user.

These principles can also be found in the TNC 620: shop-oriented programmability with graphical support, many practical cycles, and an operational design that you are familiar with from other HEIDENHAIN controls.

The TNC 620 is a compact and versatile contouring control with up to five controlled axes and a controlled spindle. Thanks to its user-friendly operation and scope of features, it is especially well suited for use on universal milling, drilling and boring machines for:

- Series and single-part production
- Tool making
- Machine building
- Research and development
- Prototypes and pilot plants
- Repair departments
- Training and education facilities

Multitouch operation

The TNC 620 comes with a keyboard and touchscreen that puts zooming, rotating and dragging all at your fingertips for fast and easy operation of the TNC 620.



Shop-oriented programming

You program conventional milling and drilling operations right at the machine, in Klar-text—the dialog-guided, shop-oriented programming language from HEIDENHAIN. With helpful dialog guidance and informative visual aids, the TNC 620 provides optimal programming support, including

For standard machining operations and even complex applications, a wealth of practical machining and coordinate transformation cycles are at your beck and call.

Offline programming

The TNC 620 is easy to program remotely as well. Its Fast Ethernet interface ensures extremely short upload times, even for long programs. In addition, data can be transferred quickly and easily via the USB interface.

CAD Viewer as standard

Display your CAD data in the .step or .iges format directly on the TNC 620. The standard integrated CAD Viewer can open many common 3D formats and display them on the TNC 620 screen.

Finely detailed graphics

Thanks to the high-resolution program verification graphics of the TNC 620, you can exactly evaluate the result of milling or drilling processes even before the actual machining operation.

Advanced Dynamic Prediction (ADP)

The TNC 620 offers its ADP function for demanding milling operations. This optimizes the motion control for all feed axes. With the TNC 620, you achieve even higher surface quality and contour fidelity.

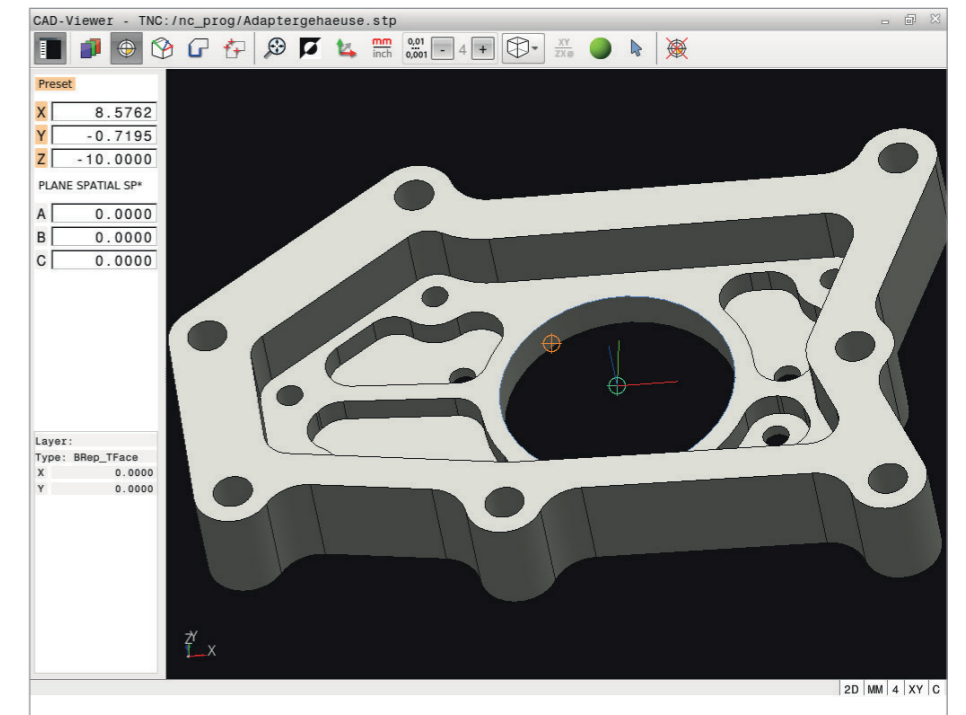
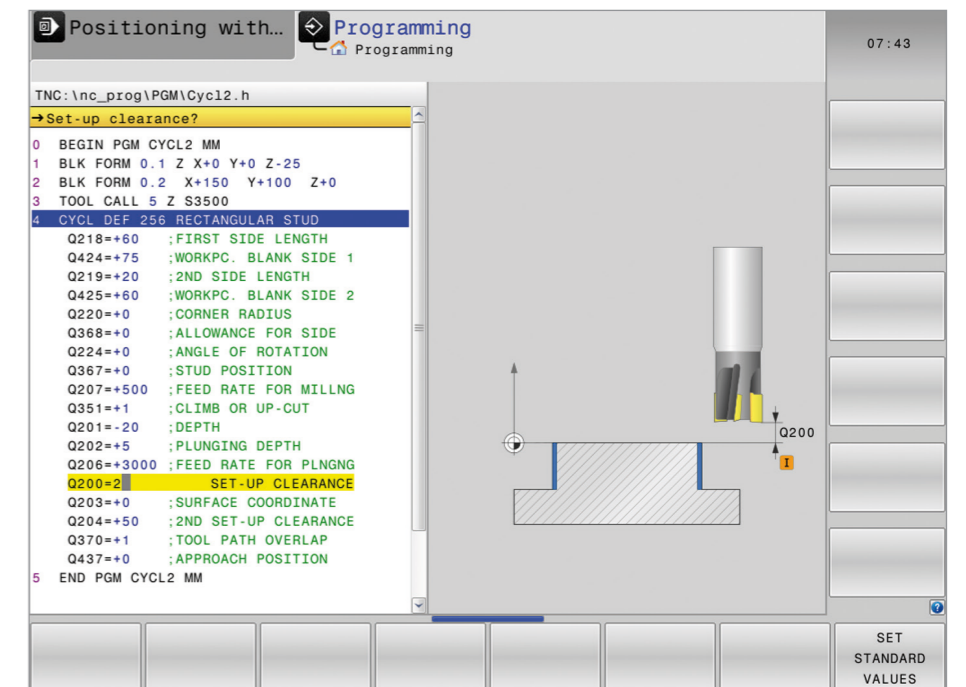

Intuitive and user-friendly

State-of-the-art multitouch operation

Monitor

In a clear format, the 19-inch screen displays all of the information you need for programming, operating, and checking the control and the machine, including program blocks, tips, and error messages. Extended Workspace Compact offers even more information: alongside the main window there is an additional window for displaying any external application. You can also use a split screen in the main window to display your NC blocks on one side and the graphical image and status display on the other. While the program is running, status displays are available that inform you about the tool position, current program, coordinate transformations, and more. The TNC 620 even displays the current machining time.

Intuitive touchscreen operation

The conventional operating approach of the TNC has proven itself over many years, with users around the world using the TNC's dialog keys, navigation keys, and soft keys. But the touchscreen version of the TNC 620 now assists you with a particularly innovative and user-friendly method of operation. This approach combines the proven benefits of the HEIDENHAIN controls with a new method that uses tapping, swiping, and dragging gestures.

Intuitive operation

The TNC 620 can be conveniently operated with a connected mouse, but many machine shops lack an adequate surface for a mouse. A touchscreen, however, eliminates the need for additional workspace for input devices and makes everyday operation of the TNC 620 even easier thanks to swiping, direct selection of operating elements, and menu navigation. The touchscreen is particularly helpful when using the CAD Import function, allowing you to rapidly zoom, drag, or select with simple gestures.

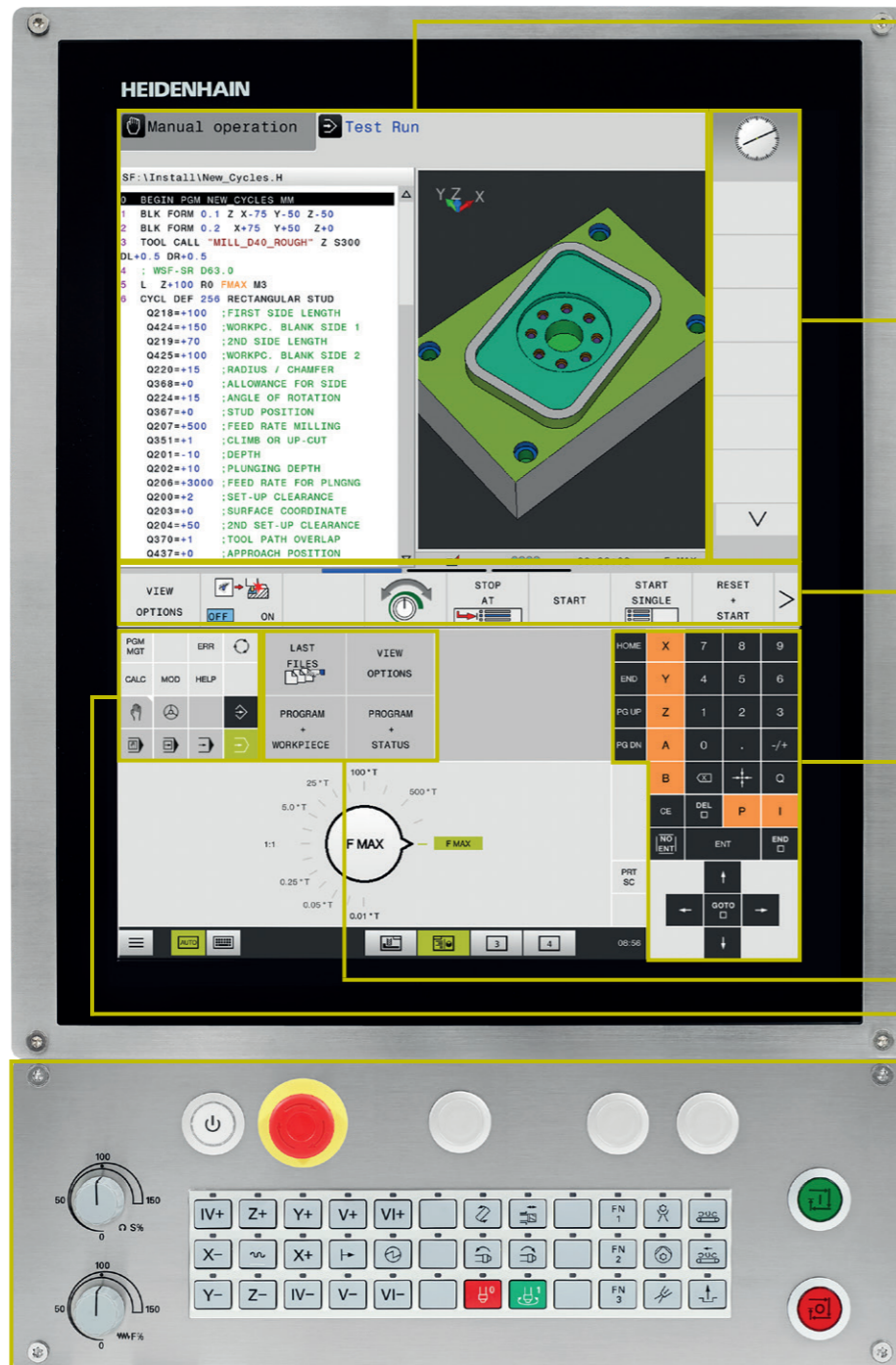

Main window for displaying two operating modes, the program, the graphical image, and the machine status

PLC soft keys for machine functions

Self-explanatory **soft keys** for NC programming

Axis keys, numeric keypad, and navigation

Quick access menu

Function keys for programming modes, machine operating modes, TNC functions, management, and navigation

Machine operating panel with snap-on keys and override potentiometers for feed rate and spindle speed

Practical touchscreen

With an IP54 rating, the touchscreen is designed to handle harsh shop conditions thanks to these characteristics:

- Dust-protected
- Splash-proof
- Scratch-proof

To clean the screen, simply select the touchscreen cleaning mode. This locks the screen to prevent unintended operation.

Gestures for multitouch operation

The screen of the TNC 620 can be operated with gestures like the ones you use on your smartphone or tablet. For example, you can zoom in or out with two fingers, or swipe to rapidly navigate through programs, menus, and the soft-key row.

Leading-edge design

The user interface of the TNC 620 boasts a sleek outer appearance with gently rounded edges, color gradients, and a pleasingly uniform font. The different screen areas are clearly delineated, and the operating modes are indicated by special operating mode symbols.

To help you evaluate the priority of error messages, the TNC 620 displays them in color-coded categories. A color-coded warning triangle is also displayed.

Symbol	Gesture
	Tap
	Double tap
	Long press
	Swipe
	Drag
	Two-finger drag
	Spread
	Pinch



Highly practical user interface

The key to safe and low-fatigue work is having an intuitive screen layout and an ergonomic, well-arranged keyboard. Although HEIDENHAIN has been adhering to these principles for a long time, the TNC 620 offers a number of features that make working with the control even simpler and easier than before.

The smartSelect functions overview

With dialog support, you can now readily select functions that were previously available only via soft key structures. As soon as you open smartSelect, you are shown a tree structure with all of the subordinate functions that can be defined in the control's current operating state. The TNC also displays integrated help on the right-hand side of the smartSelect window. When you make a selection with the cursor or per mouse click, you immediately receive detailed information about the function. The smartSelect feature is also available for the definition of machining cycles, touch probe cycles, and special functions (SPEC FCT), and for parameter programming.

Color-structured programs

The content of a program line can be quite extensive:

- Line number
- Program function
- Input value
- Comment

To help you always find your way even in complex programs, the individual program elements on the TNC 620 are shown in different colors. This allows you to see at a glance which input values are editable.

Universal table editor

Regardless of whether you are editing a tool, preset, or pallet table, the layout, method of operation, and functions of the table editor are always the same.

Info line

In the info line, the TNC 620 helps you orient yourself by displaying the respective status of the submodule.

MOD function

The additional MOD operating mode offers a wide variety of possible settings in a standardized layout, regardless of the operating mode.

User administration

The user administration feature of the TNC 620 lets you define various roles and access rights for users, ensuring that each user can act only within his assigned rights. This helps prevent the unintentional or unauthorized deletion of files and system file content. Many functions are also available only with the corresponding permissions. Consequently, the user administration feature of the TNC 620 not only increases data security but also promotes operating safety.

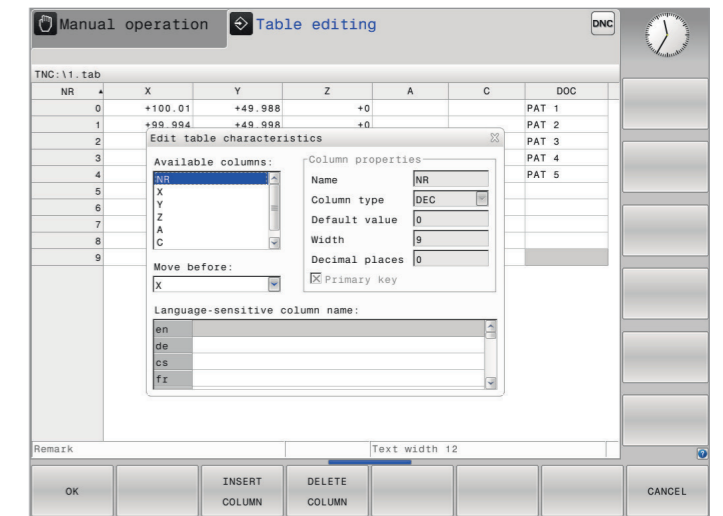
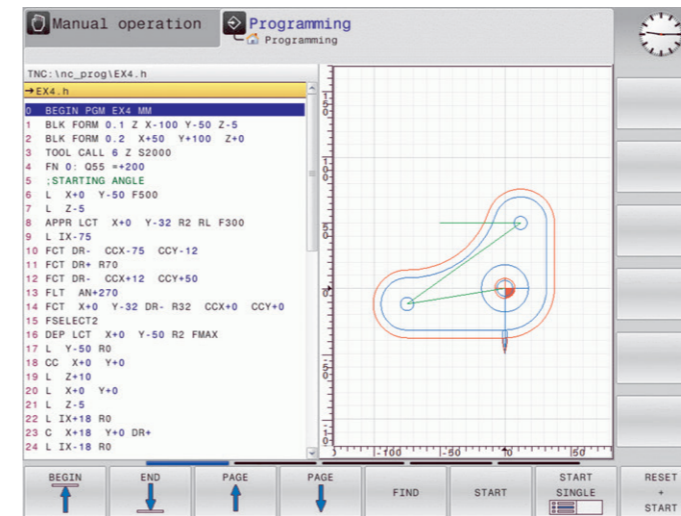
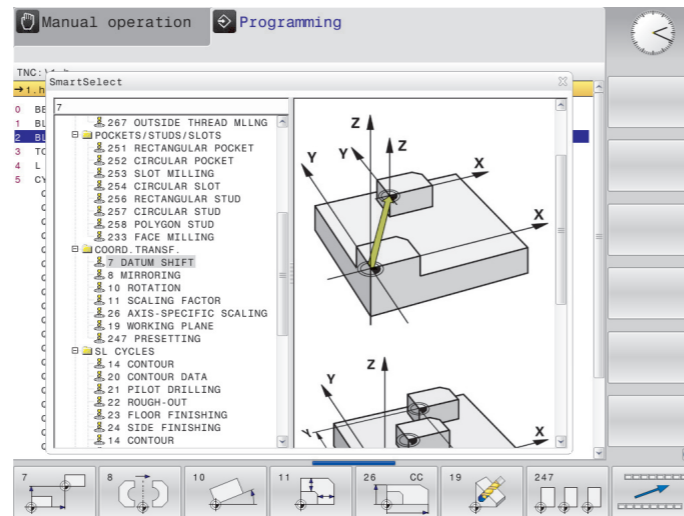
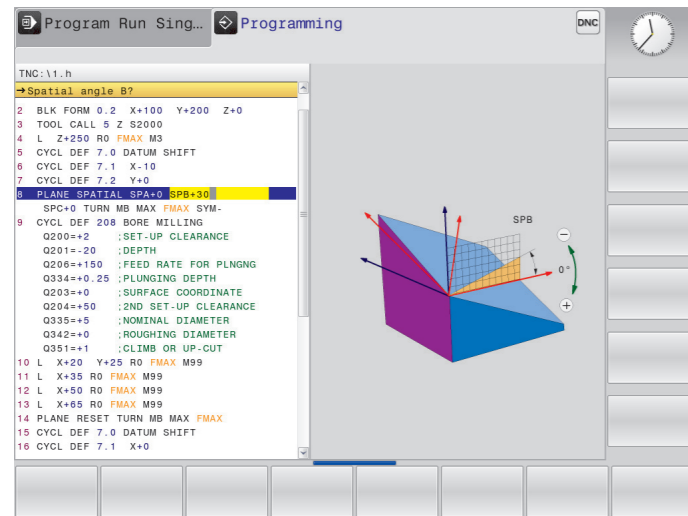

Fast and reliable machining at high contour fidelity

Optimal tool guidance by the TNC 620

High contour fidelity and surface quality

TNC controls from HEIDENHAIN are known for their low-jerk and speed/acceleration-optimized motion control, enabling optimized surface quality and workpiece accuracy. With the TNC 620, you are able to leverage the latest technological developments. The TNC 620 anticipates and thinks along with you, dynamically calculating the contour ahead of time. In addition, special filters suppress machine-specific natural frequencies.

With its Look Ahead function, the TNC 620 recognizes directional changes ahead of time and adapts the traversing speed to the shape of the contour and the surface to be machined. You simply program the maximum machining speed as the feed rate and, in Cycle 32 TOLERANCE, enter the maximum permissible deviations from the ideal contour. The TNC 620 then automatically adapts the machining operation to the selected tolerance. This method prevents contour defects.

Advanced Dynamic Prediction (ADP) expands upon the previous look-ahead calculation of the permissible maximum feed rate profile. ADP compensates for differences in the feed rate profiles resulting from the point distribution on neighboring paths, especially in NC programs originating from CAM systems. Among other benefits, this results in particularly symmetrical feed rate behavior on the back-and-forth paths during bidirectional finish milling, as well as very smooth feed rate curves on neighboring milling paths.

Fast machining and computing processes

With a short block-processing time of at most 1.5 ms, the TNC 620 can run fast look-ahead calculations for optimal use of the machine's dynamic parameters. Functions such as ADP and Look Ahead therefore ensure not only high contour fidelity and surface quality but also optimize the machining time.

One basis for the TNC 620's high speed is its fully digital control design. This includes the integrated digital drive technology from HEIDENHAIN as well as digital interfaces connecting all of the control components with each other:

- Control components via HSCI (HEIDENHAIN Serial Controller Interface)
- Encoders via EnDat 2.2

As a result, exceptionally high feed rates can be implemented. In the process, the TNC 620 is capable of interpolating up to five axes at the same time. To attain the required cutting speeds, the TNC 620 can digitally control spindle speeds of up to 100 000 rpm.

The TNC 620's powerful 5-axis machining capability even lets you economically manufacture complex 3D contours. Programs for such contours are usually created offline with CAM systems and typically contain numerous short line blocks that are transferred to the control. With its short block-processing time, the TNC 620 quickly executes even complex NC programs. The control's computing power can handle complex look-ahead calculations in simpler NC programs as well. Thus, regardless of the data volume of the NC programs from your CAM system, the TNC 620 will machine the workpiece to near-perfect conformity with your program.

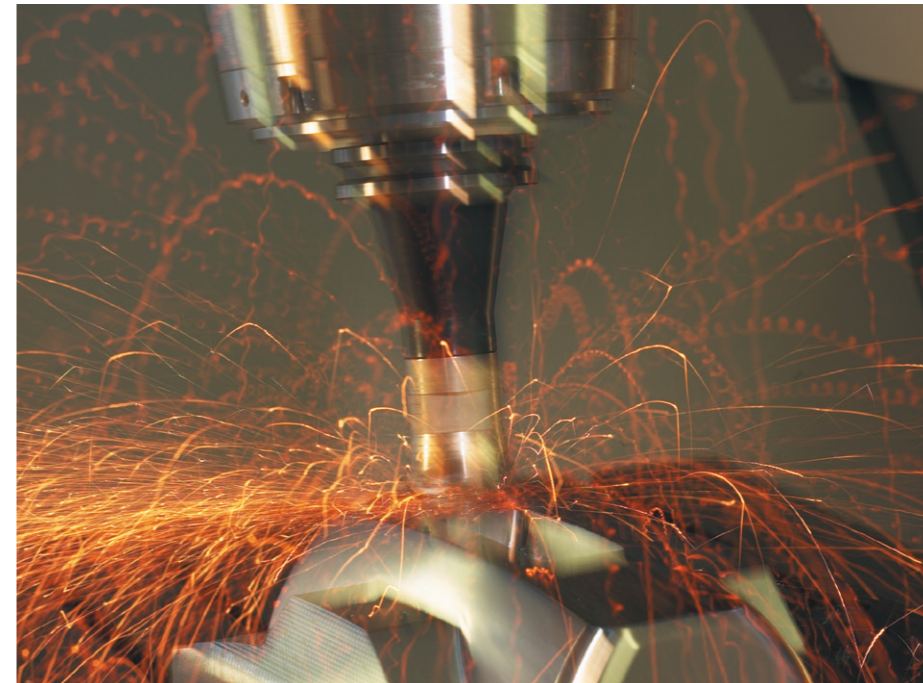

Machining with five axes

TNC 620-controlled swivel head and rotary table

Many five-axis operations that initially appear to be highly complex can be broken down into common 2D movements that have been tilted about one or more rotary axes or wrapped around a cylindrical surface. In order for you to create and edit such programs quickly and easily without a CAM system, the TNC assists you with helpful functions.

Tilting the working plane* (option)

Programs for contours and holes on inclined surfaces are often extremely complex and require time-consuming computing and programming work. But the TNC 620 can save you a great deal of programming time. You simply program the machining operation as usual in the working plane (e.g., the XY plane); the machine tool then performs the operation in the tilted plane.

The PLANE function makes it easy for you to define a tilted working plane: tilted working planes can be specified in seven different ways depending on the information available in the workpiece drawing. Help images support you during program entry.

You can also use the PLANE function to define the positioning behavior during tilting to avoid unpleasant surprises when the program is run. The settings for defining the positioning behavior are identical for all PLANE functions, making operation much easier.

* The control must be adapted for these functions by the machine manufacturer.



Cylinder surface machining* (option)

The programming of contours made up of straight lines and circles on cylindrical surfaces for rotary tables is no problem with the TNC 620. You simply program the contour in the plane of an unrolled cylinder surface. The TNC 620 then performs the machining operation on the cylindrical surface of the cylinder.

The TNC 620 features four cycles for cylindrical surface machining:

- Slot milling (the slot width and tool diameter are equivalent)
- Guide-groove milling (the slot width is greater than the tool diameter)
- Ridge milling
- Outside contour milling

* The control must be adapted for these functions by the machine manufacturer.



Manual axis motion in the tool direction on 5-axis machines

Correct tool retraction is very important in five-axis machining. The virtual tool axis function provides assistance by allowing you to move the tool in the direction of the tool axis using external direction keys or a handwheel. This function is especially useful if you want to

- retract the tool in the direction of the tool axis during an interruption of a five-axis machining program,
- use the handwheel or external direction keys to perform an operation in Manual mode with an inclined tool, or
- move the tool with the handwheel in the active tool axis direction during machining.

Feed rate for rotary tables in mm/min* (option)

By default, rotary axis feed rates are programmed in degrees/min, but the TNC 620 can also interpret these feed rates in mm/min. The feed rate at the contour is then independent of the distance of the tool center point from the center of the rotary axis.

Polar kinematics

With polar kinematics, the motions in the working plane are performed by one linear axis and one rotary axis. This greatly increases the machining operations possible on machines which have only two linear axes. For example, front-face operations become possible on rotary and cylindrical grinding machines. And on milling machines, suitable rotary axes can replace various linear axes, for example when working on very large surfaces on large machine tools.

Minimize setup times

The TNC 620 makes setup easy

Before machining can begin, the workpiece must first be clamped, the machine must be set up, the position of the workpiece in the machine must be determined, and the preset must be set. This is a time-consuming but indispensable procedure because any error directly reduces the machining accuracy. Particularly in small and medium-sized production runs, as well as in the case of very large workpieces, setup times become a significant factor.

The TNC 620 features application-oriented, real-world setup functions that assist the user, help reduce non-productive time, and enable overnight, unattended production. In conjunction with the touch probes, the TNC 620 offers numerous probing cycles for automatic workpiece setup, setting the preset, and measuring workpieces and tools.

The TNC 620 supports L-shaped styli in the probing cycles, which are used to quickly and easily probe undercuts.

Fine manual axis control

During setup, you can use the axis-direction keys to move the machine axes manually or with an incremental jog. A simpler and more reliable way, however, is to use the electronic handwheels from HEIDENHAIN. With these handwheels, you are always close to the action, enjoy a close-up view of the setup process, and can control the infeed responsively and precisely.

Adapting the probing speed

In many cases, the workpiece must be probed at unseen positions or in cramped spaces, and the standard probing feed rate is usually too fast for this. In such situations, you can use the override knob to change the feed rate during probing without affecting the accuracy.

Workpiece alignment (option)

The HEIDENHAIN touch probes and probing functions of the TNC 620 reduce the need for tedious manual alignment of the workpiece:

- You start by simply clamping the workpiece in any position.
- The touch probe probes a surface to determine the amount of workpiece misalignment.
- The TNC 620 subsequently compensates for the misalignment by performing a "basic rotation," in which either the NC program is executed at the ascertained angle of rotation or the rotary table is turned in order to correct the misalignment.

The TNC 620 offers you a comprehensive package of cycles for setting up the machine tool:

- Manual, automatic, and semiautomatic cycles for presetting and for compensating for misalignments in two or three dimensions
- Automatic probing cycle for repeating a measurement along a line

Setting presets

A preset allows you to assign a defined value displayed by the TNC to any position on the workpiece. Finding this point quickly and reliably reduces non-productive time and increases machining accuracy.

The TNC 620 features probing cycles for automatically setting presets. Ascertained presets can be saved as follows:

- Using the preset management
- In a datum table
- Through direct setting of the display

Preset management with the preset table

Preset management enables flexible machining, shorter setup times, and higher throughput. Setting up your machine is greatly simplified.

In preset management, you can save any number of presets and assign an individual basic rotation to each one. In order to permanently save fixed presets in the machine's workspace, you can also write-protect individual lines.

There are three possibilities for rapidly saving the presets:

- Via a soft key in Manual mode
- Via the probing functions
- With the automatic probing cycles

Saving datums

Datum tables let you save positions or measured values from the workpiece. Datums are always defined relative to the active preset.

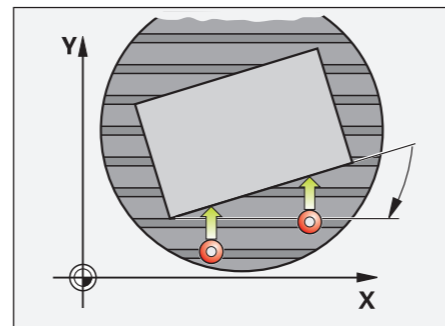
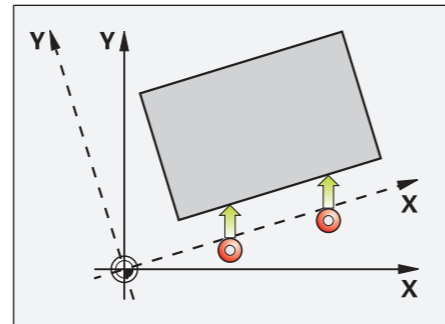

Workpiece misalignment compensated for by rotating the coordinate system or rotating the table

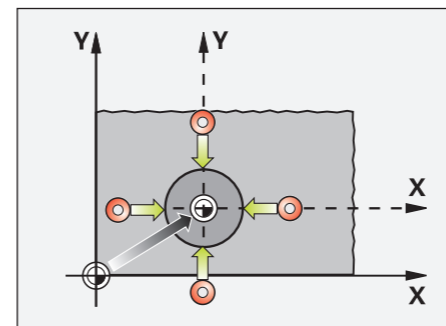
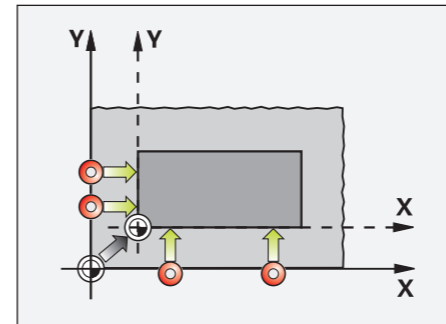

Setting a preset at a corner, for example, or in the center of a circular stud

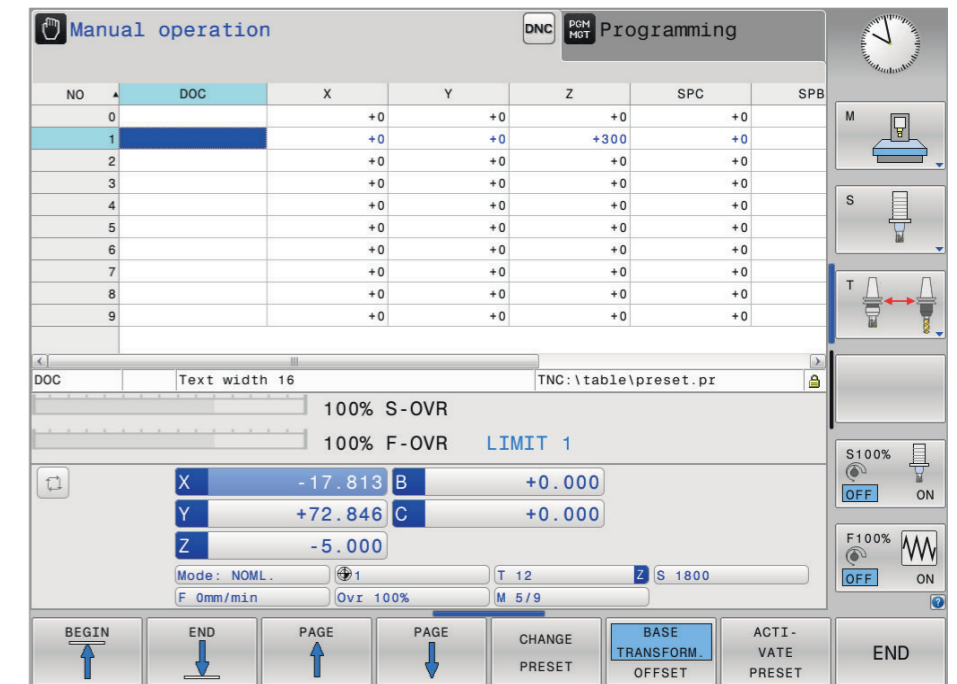

Automated machining

The TNC 620 measures, manages and communicates

The requirements gap between machining centers and typical tool and moldmaking machines is becoming ever narrower. Of course, the TNC 620 is also very capable of controlling automated manufacturing processes. It features the necessary functionality to initiate the proper machining operation in concatenated machining scenarios with individual workpieces in any workholding arrangement.

Inspecting workpieces for proper machining and dimensional accuracy (option)

The TNC 620 features a number of measuring cycles for checking the geometry of the machined workpieces. This requires inserting a touch probe from HEIDENHAIN into the spindle in place of the tool. This allows you to do the following:

- Recognize a workpiece and call the appropriate part program
- Check whether all machining operations were conducted correctly
- Determine infeeds for finishing
- Detect and compensate for tool wear

- Inspect workpiece geometry and sort parts
- Log measured data
- Ascertain the machining trend
- Check tolerances and configure various reactions, such as an error message

Milling-tool measurement and automatic compensation of tool data (option)

In conjunction with the TT tool touch probe, TNC 620 lets you automatically measure milling tools in the machine. The TNC 620 then stores the determined values, such as tool length and radius, in its tool memory. By inspecting the tool during machining, you can quickly detect wear or breakage for preventing scrap and rework. If the measured deviations lie outside the specified tolerances or if the monitored tool life has been exceeded, the TNC 620 locks the tool and automatically inserts a replacement tool.

Tool management*

For machining centers with automatic tool changers, the TNC 620 offers a central tool memory for any number of milling tools. This tool memory area is a freely configurable file that can be optimally adapted to your needs. You can even have the TNC 620 manage your tool names. The control prepares the next tool change while the current tool is still cutting. This significantly reduces the non-cutting time required for tool changes.

With the tool manager, the control now shows only the required input fields based on the selected tool type. Any data can also be graphically depicted. Extended tool management adds the "Tooling list" and the "T usage order". These tables enable you to detect the tool requirements in time and thus prevent interruptions during program run.

* The control must be adapted for these functions by the machine manufacturer.

Monitoring functions, pallet management and multiple machining

Component monitoring (option)

Overload often leads to damaged machine components, and therefore to machine downtime. For example, the spindle bearing is often subject to a very high load in machining strategies that have been optimized for maximum efficiency, and can therefore sustain undetected damage. Component Monitoring warns you about these dangers, and can even stop the machine tool if necessary. Thanks to continuous monitoring of the bearing load and visualization of these values, the machining processes can be optimized correspondingly.

However, the production quality of a machine tool is influenced not only by overload. Components that are constantly under load, such as guideways or the recirculating ball screw, are subject to wear and thus have an influence on the finished product. TNC 620 uses the Component Monitoring software option to measure and document the momentary machine status. The machine manufacturer can read and evaluate these data, and react using predictive maintenance, thereby avoiding unplanned machine downtimes.

The MONITORING HEATMAP function within the NC program lets you color the concurrent material removal simulation in the workpiece view with the status of a monitoring task. That way you see in the workpiece view where a component is subject to an excessive load.

Pallet management

Pallet management functionality lets you automatically machine workpieces in any order. Upon insertion of the pallet, the correct machining program and preset are automatically selected. You can also apply coordinate transformations and measuring cycles in the part programs. A pallet counter function lets you easily define the desired quantity to be produced.

Batch Process Manager (option)

Batch Process Manager is a powerful function for pallet machining and series production. Its straightforward user interface helps you plan your production process and gather important information on upcoming machining operations.

Batch Process Manager automatically checks for missing tools, insufficient tool life, and required manual tool changes. The results are displayed in the status overview.

Batch Process Manager shows the following information in advance:

- The machining sequence
- The time of the next manual intervention
- The program duration and run time
- Status information about preset, tool, and program

Tool-oriented machining

In tool-oriented machining, a single machining step is performed on all of a pallet's workpieces before moving to the next machining step. This keeps the number of tool changes to a minimum and significantly shortens the machining time.

The TNC 620 assists you with convenient fillable forms that allow you to assign a tool-oriented operation to a pallet with multiple workpieces. As always, you still write the machining program in the normal workpiece-oriented sequence.

You can also use this function even if your machine does not support pallet management. In this case, you simply define the position of the workpiece on the machine table in the pallet file.

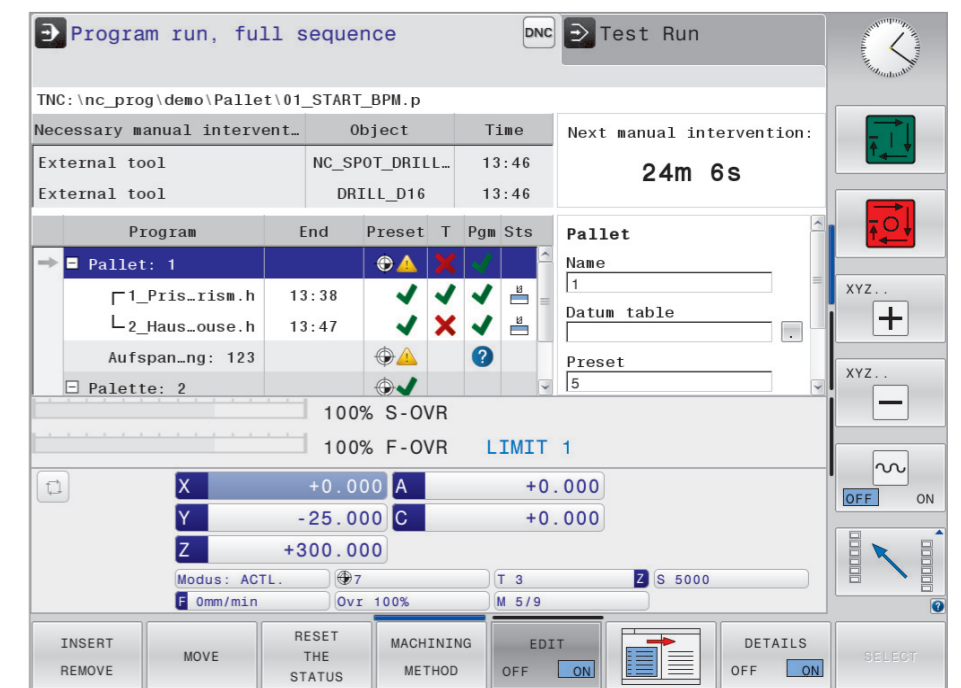
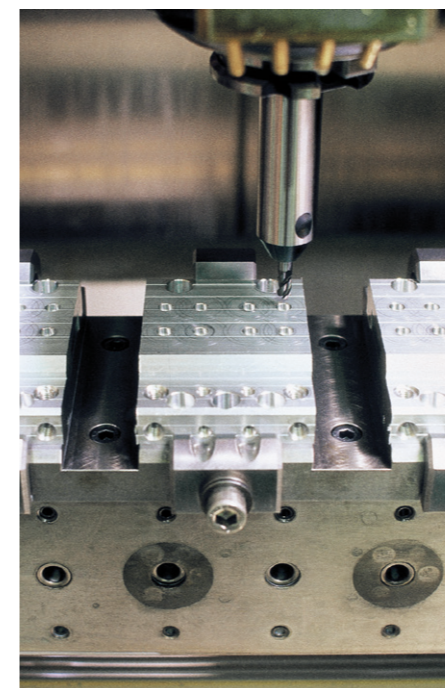

Programming, editing and testing

A full range of possibilities with the TNC 620

Graphical support in any scenario

Besides being universally deployable, the TNC 620 is equally flexible when it comes to programming, setup, and machining.

Individual machining steps

You don't need to create a complete program in order to start machining with the TNC 620. You can machine a workpiece step by step using both manual machining and automatic positioning in any sequence.

Programming at the machine

HEIDENHAIN controls are workshop oriented, which means that they were conceived for programming right at the machine. Instead of requiring you to know G codes, the Klartext conversational programming language provides its own buttons and soft keys for programming straight lines, arcs, and cycles. At the push of a button, HEIDENHAIN Klartext dialog guidance opens and actively helps you during programming on the TNC. Its clear instructions prompt you to enter all of the required data.

All interface texts, including Klartext tips, dialog prompting, program steps, and soft keys, are available in numerous languages.

And even if you prefer ISO programming, the TNC is still the right control: you can enter ISO command letters via soft keys or directly on the alphanumeric keyboard.

Programming graphics

The two-dimensional programming graphics give you additional assurance: while you are programming, the TNC 620 renders every programmed movement on the screen. You can opt for a plan view, side view, or front view. Tool paths or rapid-traverse movements can be hidden, and the image's scale can be changed.

Program verification graphics (option)

For added certainty prior to machining, the TNC 620 can simulate and render the machining of the workpiece at high resolution. The TNC 620 can present different views of the simulation:

- Plan view at different levels of depth
- Three projections
- 3D view

The type and quality of the image can be selected, and details can be displayed at magnification. The TNC 620 also displays the calculated machining time in hours, minutes, and seconds. You can use STL files to integrate workpiece blanks and finished parts in the program.

The 3D view lets you display the programmed tool-center path in three dimensions, and a powerful zoom function lets you see even the tiniest details. The 3D line graphics are especially helpful in verifying programs created offline, allowing you to avoid undesired machining marks on the workpiece, such as those that occur when the postprocessor outputs points incorrectly. In 3D view, the TNC also includes a measuring function. When you move the mouse pointer anywhere within the image, the coordinates of that position are displayed. The measurement window also displays tool information.

During the machining simulation, the TNC 620 can also display all of the machine components defined by the machine manufacturer, in addition to the workpiece and tool. This rendering capability is particularly useful in Test Run mode, informing you ahead of time which positions are too close to components and when the traversing path will be insufficient. This is a huge benefit during machining with tilting axes.

Program-run graphics (option)

The program-run graphics display the workpiece in real time in order to show you the machining progress. Direct observation of the workpiece is usually impossible due to coolant and the safety enclosure. During machining, you can switch between various operating modes at any time in order to create programs, for example. And at the press of a button, you can cast a glance at the machining progress while programming.

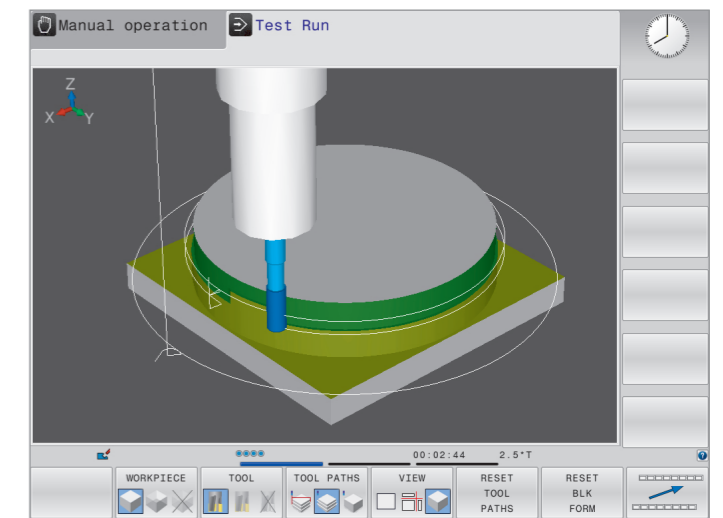
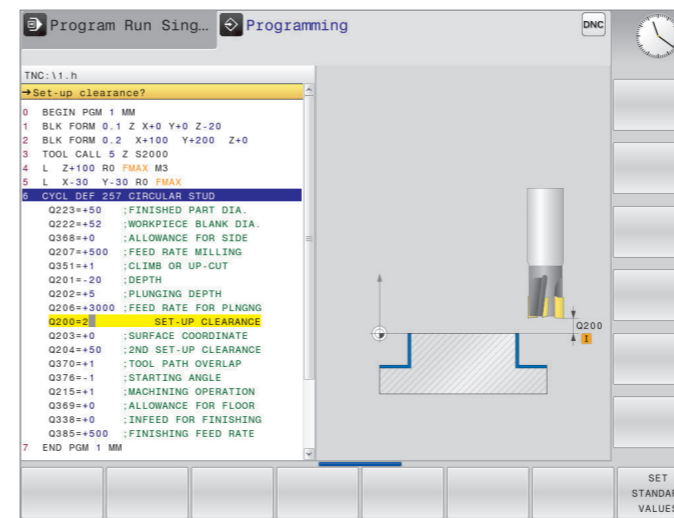
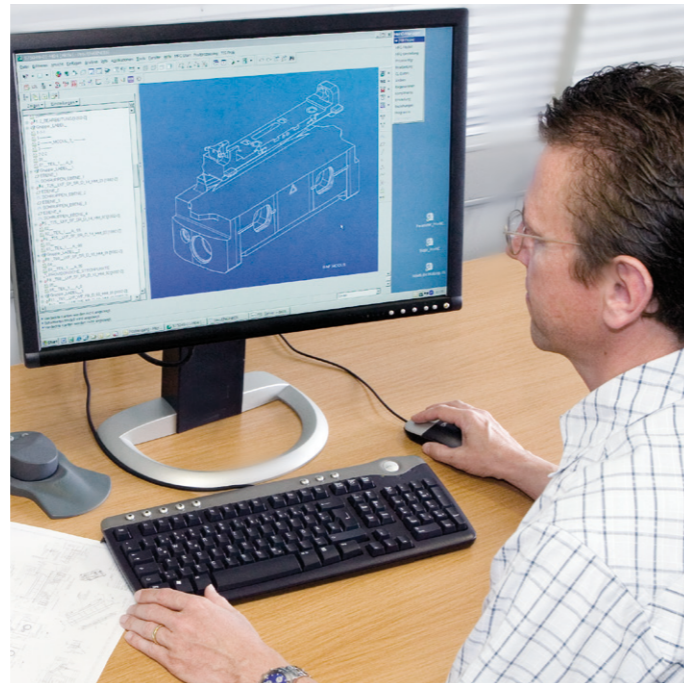

Programming on the shopfloor

Straightforward function keys for complex contours

Programming 2D contours

Two-dimensional contours are the bread and butter of a modern machine shop, which is why the TNC 620 offers a variety of ways to handle them.

Programming with function keys

Are the contours properly dimensioned for NC machining? In other words, are the end points of the contour elements provided in either Cartesian or polar coordinates? If yes, then you can create the NC program straightaway using function keys.

Straight lines and circular elements

To program a line segment, for example, simply select the "linear traverse" path function. The Klartext conversational programming language of the TNC 620 then prompts you for all of the information needed by the programming block, including the target coordinates, feed rate, tool compensation value, and machine functions. Functions for circular movements, chamfers, and corner rounding also simplify your programming work. In order to avoid surface blemishes during approach or departure from the contour, movement must be seamless—that is, tangential.

You simply specify the starting point or end point of the contour and the approach or departure radius of the tool. The control handles the rest.

The TNC 620 can foresee a contour with radius compensation by up to 99 blocks, thus taking back-cutting into account and avoiding contour gouging. This could be the case, for example, when roughing a contour with a large tool.

Programming free contours and Data Matrix codes

Fast and easy programming of a scannable Data Matrix code

Cycle 224 (Data Matrix code pattern) lets you convert any text into a Data Matrix code and machine it onto your workpiece as a point pattern using, say, drilling operations. The Data Matrix code can be decoded with common scanning devices. Serial numbers and production data can thus be permanently machined onto the part. All you need to do after defining a machining cycle is enter the text (up to 255 characters) into the cycle and specify the size and position of the drilling pattern. The control automatically calculates the Data Matrix code and performs the machining work on its own.

FK free contour programming (option)

Not all workpieces are properly dimensioned in accordance with the ISO standard. Thanks to FK, the control's programming function for free contours, you can simply enter the known data without needing to convert or calculate anything! In such cases, individual contour elements can remain undefined as long as the overall contour itself is defined. If the data allow for more than one mathematical solution, then the TNC 620 programming graphics helpfully render the possible variants to choose from.

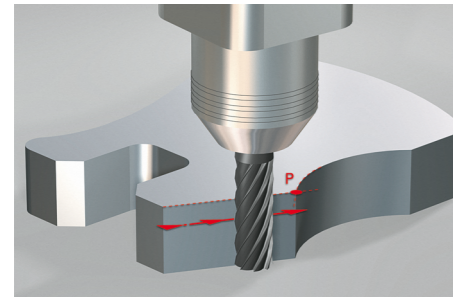
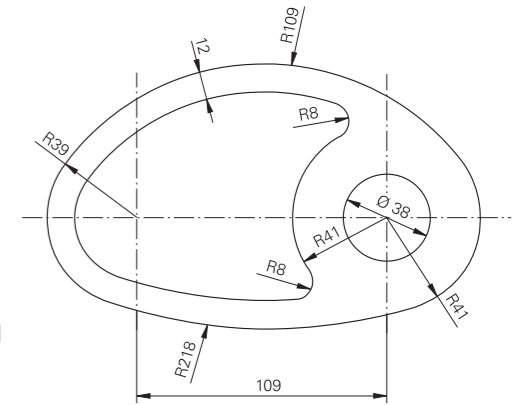

L Straight line defined by its end point

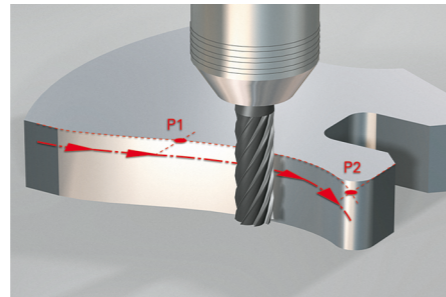

CT Circular path with seamless (tangential) transition from the preceding contour element, defined by its end point

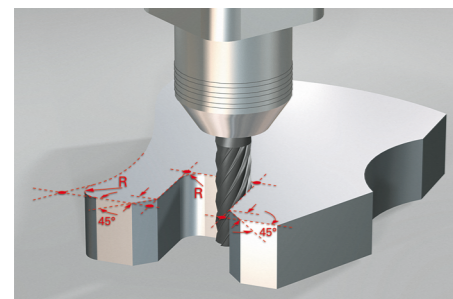

RND Corner rounding: circular path with a seamless (tangential) transition, defined by its radius and corner point

CHF Chamfer defined by the corner point and chamfer length

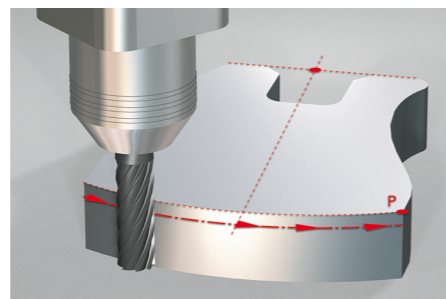

CC + C Circular path defined by its center, end point, and rotational direction

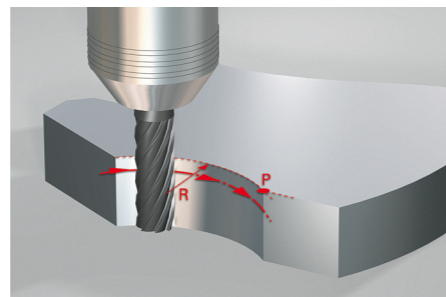

CR Circular path defined by its radius, end point, and rotational direction

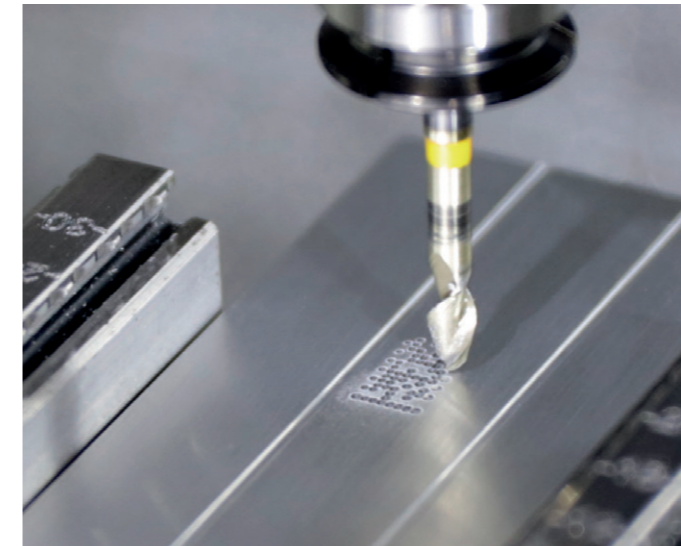

Practical cycles for recurring operations

Extensive machining cycles for milling and drilling

The TNC 620 offers you a package covering a broad range of cycles, so you'll surely find the right one for each task. The cycles are divided into groups based on the machining technologies and strategies, ensuring that you always maintain a clear overview. You program them using conversational guidance, assisted by graphics that clearly illustrate all required input parameters.

Standard cycles

In addition to drilling and tapping cycles (with or without a floating tap holder), a variety of selectable cycles are available:

- Thread milling
- Reaming
- Engraving
- Boring
- Hole patterns
- Milling cycles for face milling a flat surface
- Roughing and finishing of pockets, slots, and studs

Cycles for complex contours (option)

Of great help in roughing pockets with any contour are the control's SL cycles (SL = Subcontour List) and OCM cycles (Optimized Contour Milling software option). These functions refer to machining cycles for pilot drilling, roughing, and finishing in which the contour or subcontours are defined in subprograms. As a result, a single contour description can be used for various operations with different tools.

Up to twelve subcontours can be superimposed for the machining operation. The control automatically calculates the resulting contour and the tool paths for roughing or clearing the surfaces.

Subcontours can be pockets or islands. Multiple pockets are combined to form a single pocket, with the tool bypassing any islands. You can also program void areas that are excluded from machining. This significantly reduces machining times for cast parts or pre-machined workpieces.

During roughing, a finishing allowance on the wall and floor surfaces is also taken into account by the TNC 620. When roughing with different tools, the control identifies residual material to be removed by smaller tools. A separate cycle is used for finishing to the final dimensions.

OEM cycles (option)

As original equipment manufacturers (OEMs), machine manufacturers can contribute their special manufacturing know-how by designing additional fixed cycles and saving them in the TNC 620. However, the user can write his own cycles as well. HEIDENHAIN makes this possible with its PC software CycleDesign, which allows you to create input parameters and arrange the menu key structure of the cycles as desired.

Programming machining patterns with ease and flexibility

Positions to be machined are often arranged in patterns on the workpiece. The TNC 620's graphical support helps you program a wide range of machining patterns with ease and exceptional flexibility. You can define as many point patterns as desired with various numbers of points. During machining, you can then have all of the points executed as a unit, or each point individually.

3D machining with parametric programming

Simple, mathematically easy-to-describe 3D geometries can be programmed by means of parametric programming. At your disposal are basic arithmetical operations, trigonometric functions, roots, powers, logarithmic functions, parentheses, and logical comparisons with conditional jump instructions. Parametric programming also gives you a simple way to implement 3D operations.

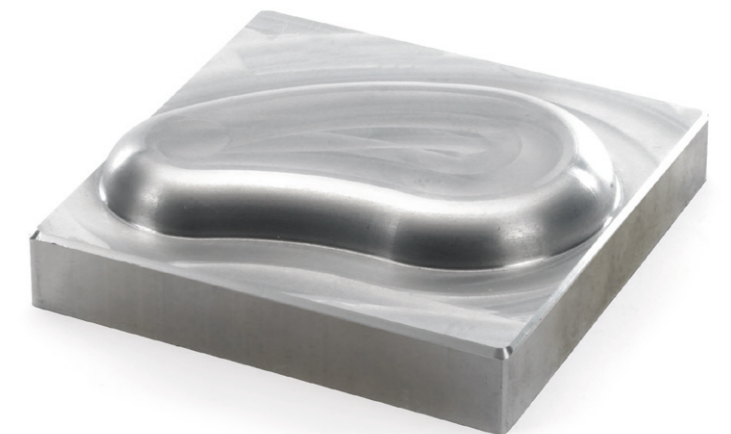
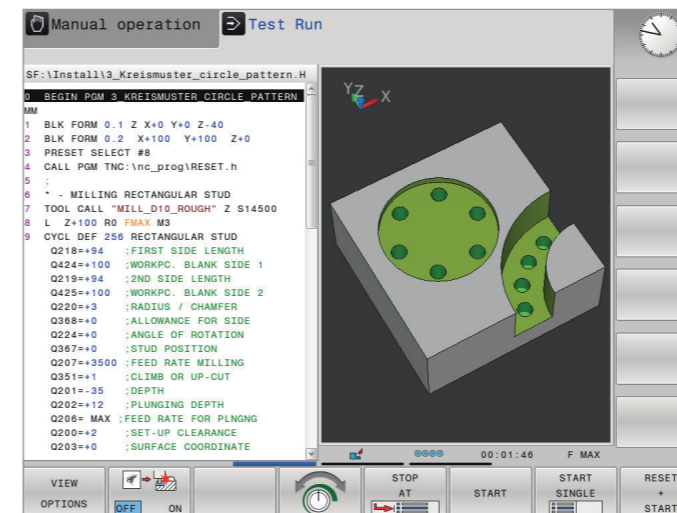
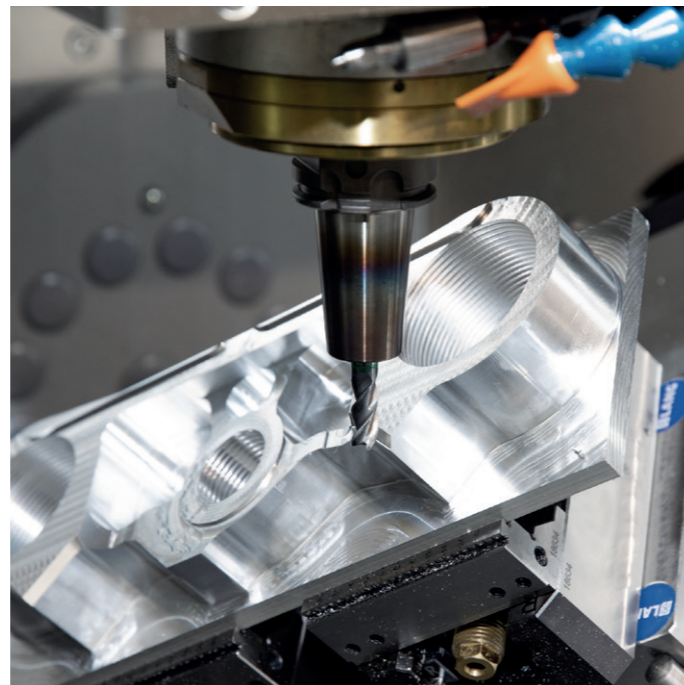
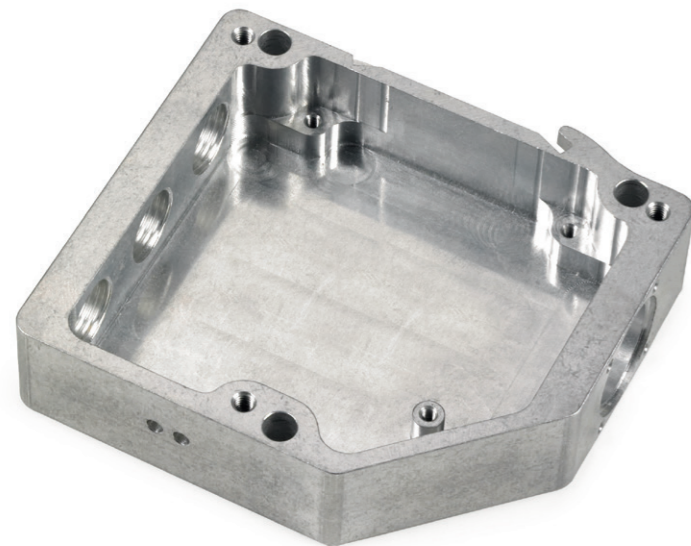

Coordinate transformations

If you need a pre-programmed contour at different locations and in different sizes on the workpiece, then the TNC 620 offers you a convenient solution in the form of coordinate transformations.

With coordinate transformation you can, for example, rotate or mirror the coordinate system, or shift the datum. With a scaling factor you can enlarge or reduce contours to respect shrinkage or oversizes.

Program-section repeats and subprograms

Many machining operations repeat themselves either on the same workpiece or on different workpieces. Once you have programmed a detail, there is no need to program it again. With its subprogram technology, the TNC can save you a great deal of programming time.

In program-section repeats, you can label a section of the program, and the TNC will repeat this section as many times as required.

You can mark a program section as a subprogram and then call it at any point in the program and as often as you want.

With the program call function, you can even use a completely separate program at any location in your current program. This allows you to leverage already programmed and frequently required working steps or contours.

Of course, you can also combine these programming techniques as often as desired.

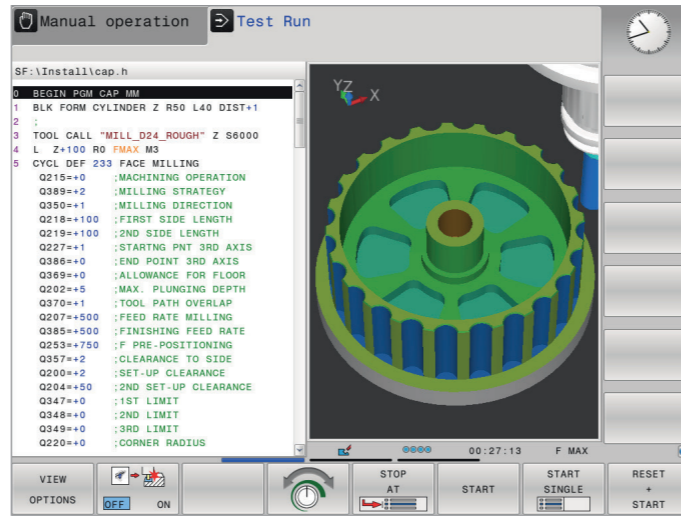

Do you have questions about a programming step, but your User's Manual is not at hand? No problem: both the TNC 620 control and the TNC 620 programming station feature TNCguide, a convenient help system that displays the user documentation in a separate window.

You can activate TNCguide simply by pressing the HELP key on the TNC keyboard or directly on the touchscreen or by clicking any soft key when the mouse pointer has switched to a question mark. This is easily done by clicking the help icon permanently displayed on the TNC screen.

TNCguide generally displays the information instantaneously and in the correct context (context-sensitive help), immediately giving you the information you currently need. This function is particularly helpful for soft keys and provides a detailed explanation of their effects.

You can download the documentation in the desired language free of charge from the HEIDENHAIN website and save it to the appropriate language directory of the TNC hard disk.

The following user's manuals are available in the help system:

- Klartext Programming
- Setup, Testing, and Running NC Programs
- Programming of Machining Cycles
- Programming of Measuring Cycles for Workpieces and Tools
- ISO Programming
- TNC 620 Programming Station (installed only with the programming station)

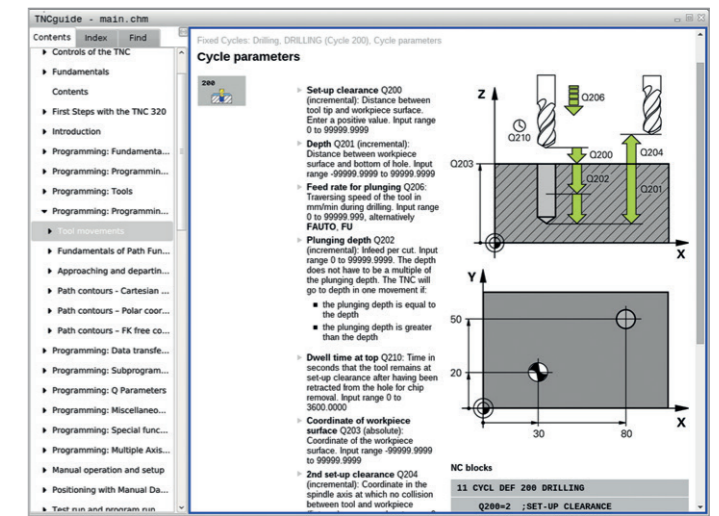
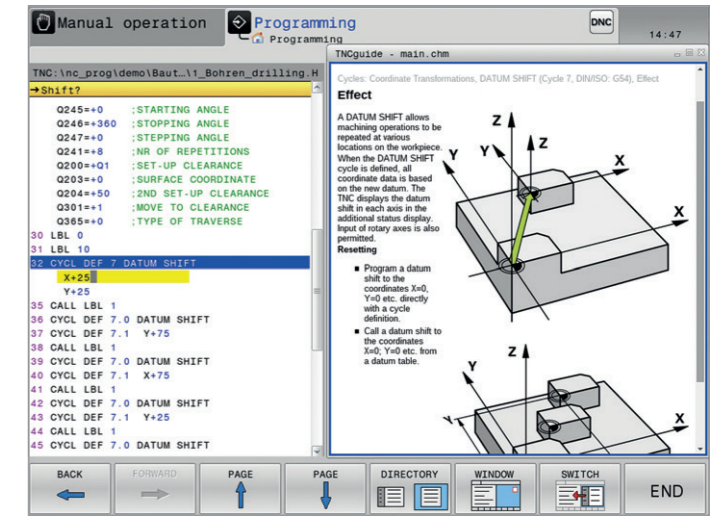

dynamic + precision

The TNC 620 is designed for exceptional accuracy and surface quality at high machining speeds, regardless of whether you are milling or turning. A variety of technologies, cycles and functions operating separately or in concert ensure perfect surface finishes in extremely short machining times:

- Optimized motion control
- Effective jerk reduction
- Dynamic contour look-ahead

The term Dynamic Precision covers a number of HEIDENHAIN cutting solutions that can dramatically improve the dynamic accuracy of a machine tool. These solutions shed new light on the competing demands of accuracy, high surface quality, and short machining times. The dynamic accuracy of machine tools manifests itself in deviations at the tool center point (TCP). These deviations depend on kinetic quantities such as speed and acceleration (including jerk) arising from the vibration of machine components and other factors.

All of these factors contribute to dimensional inaccuracy and the formation of defects on the workpiece surface, thereby impacting both quality and productivity (in the case of quality-related scrap). Dynamic Precision counteracts these problems with intelligent control technology to help improve the quality and dynamic performance of a machine tool. As a result, production time and cost are reduced.

Dynamic Precision contains the following functions, which can be deployed separately or in combination.

Function		Benefits
CTC Cross Talk Compensation	Compensation of acceleration-dependent position errors at the TCP	Greater accuracy during acceleration phases
MVC Machine Vibration Control	Damping of machine oscillations <ul style="list-style-type: none"> • AVD (Active Vibration Damping): Compensates for undesired effects of vibrations on the feed axes • FSC (Frequency Shaping Control): Suppresses the inducement of vibrations through a correspondingly filtered feedforward control 	A superior surface finish
CTC + MVC	–	Faster and more accurate machining
PAC Position Adaptive Control	Position-dependent adaptation of control parameters	Greater contour fidelity
LAC Load Adaptive Control	Load-dependent adaption of control parameters and the maximum axis acceleration	Higher accuracy whatever the load
MAC Motion Adaptive Control	Motion-dependent adaptation of control parameters	Less vibration and higher maximum acceleration during rapid traverse

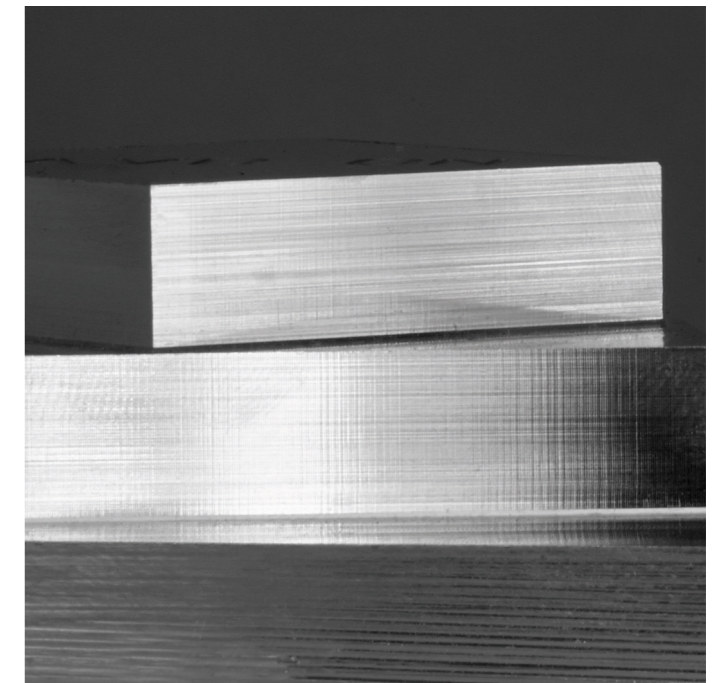
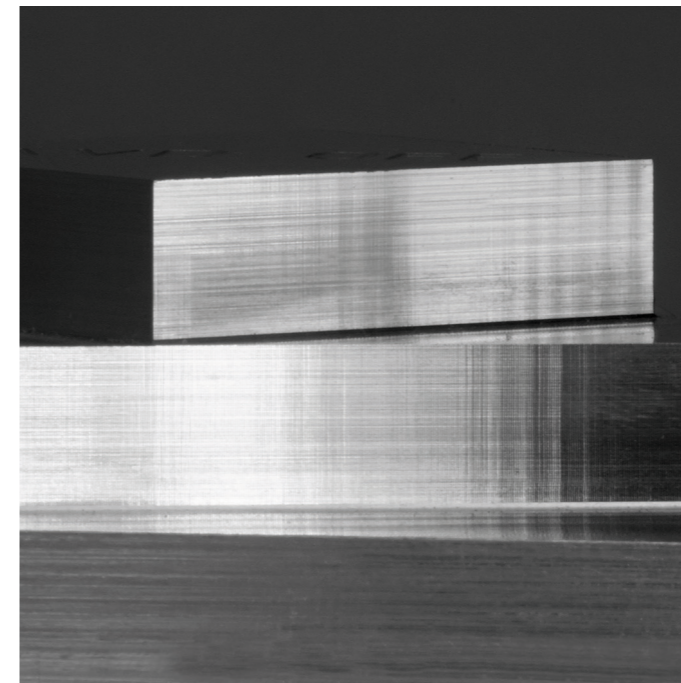

Vibration can significantly impair surface quality.

Visibly superior surface quality can be attained with MVC.

Machine any contour slot with trochoidal milling

The ability to machine any slot at high efficiency from start to finish is the key benefit of trochoidal milling. In this cycle, roughing is performed with circular movements, onto which a forward linear movement is superimposed. This procedure is referred to as trochoidal milling. It is used particularly for milling high-strength or hardened materials, where the high loads placed on the tool and machine usually only permit small infeeds.

Thanks to the special cutting motion used in trochoidal milling, however, there are no added wear-inducing influences on the tool, and higher infeeds are possible. During hobbing, the entire cutting edge can be used as well. You thereby attain a higher material removal rate per tooth. Circular-motion plunging into the material exerts less radial force on the tool. This reduces the mechanical load on the machine and prevents vibration.

The slot to be machined is described in a contour subprogram as a contour train. You define the dimensions of the slot and the cutting data in a separate cycle. Any residual material can then be easily removed with a subsequent finishing cut.

- The main benefits are as follows:
- Contact over entire cutter length
 - Higher removal rates
 - Less strain on the machine
 - Less vibration
 - Integrated finishing of the side wall
 - Superior chip removal

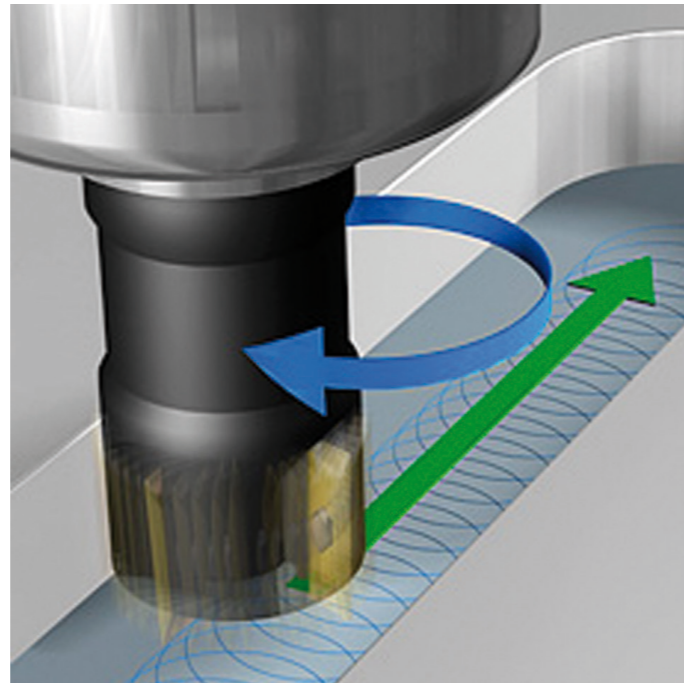

Active chatter control (ACC, option)

Roughing operations (power milling) give rise to strong milling forces. Depending on the rotational speed of the tool, the resonances in the machine tool, and the material removal rate during milling, the tool may begin to "chatter." Chatter puts the machine under heavy strain and causes blemishes on the workpiece surface. Tool wear is also accelerated and less evenly distributed. In extreme cases, the tool may even break.

To reduce chatter susceptibility, HEIDENHAIN now offers a highly effective optional control function called Active Chatter Control (ACC). This option is particularly beneficial during heavy machining:

- Improved cutting performance
- Higher removal rates (up to 25% and more)
- Lower forces on the tool, with increased tool life
- Less strain on the machine



Heavy machining without ACC (upper image) and with ACC (lower image)



dynamic + efficiency

Efficient machining strategies are a key basis for economical NC manufacturing. Roughing processes, in particular, offer great potential for optimization because they usually make up a sizable portion of the total machining time.

Process reliability and maximum removal rates require optimal adaptation of the cutting data to the characteristics of the tool and workpiece material. Optimized Contour Milling (OCM) gives the user a cutting data calculator that draws on a comprehensive integral materials database. You can adapt the automatically calculated cutting values with regard to the mechanical and thermal load on the tool. Tool service life can be managed with process reliability even at the highest possible removal rates.

With OCM, you can rough out any pocket and island with high process reliability and lower tool wear thanks to highly consistent process conditions. You simply program the contour as usual directly in Klartext or make use of the convenient CAD Import function. The control then automatically calculates the complex movements required for maintaining consistent process conditions. OCM takes void areas into account, which significantly reduces machining times (with NC software version 16 or later).

Advantages of OCM over conventional machining:

- Reduced thermal load on the tool
- Superior chip removal
- Consistent tool contact conditions
 - Higher cutting parameters
 - Higher material removal rates

OCM is an effective, reliable, and convenient way to improve your throughput

- Create programs on the shop floor for any pocket or island
- Significantly higher machining speed
- Considerable reduction in tool wear
- More chips in less time

The OCM option provides practical cycles for roughing, side-wall finishing, and floor finishing.

OCM also permits chamfering and deburring of contours. With this capability, only those areas that can be machined without collisions due to the tool geometry are machined. In order to machine

Conventional machining

S5000, F1200, a_p : 5.5 mm

Overlap factor: 5 mm

Machining time: 21 min 35 s

Tool: VHM end mill (Ø 10 mm)
Workpiece material: 1.4104

Machining with OCM

S8000, F4800, a_p : 22 mm

Overlap factor: 1.4 mm

Machining time: 6 min 59 s

Tool: VHM end mill (Ø 10 mm)
Workpiece material: 1.4104

standard shapes, OCM offers various figures that are then used as a pocket, island, or boundary for face milling in conjunction with other OCM cycles.

In the following machining example, both the machining time and tool wear were reduced by a factor of three.

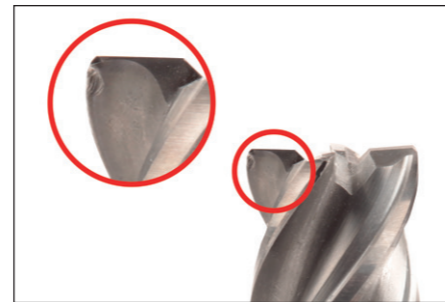

Machining without OCM: Tool after two parts

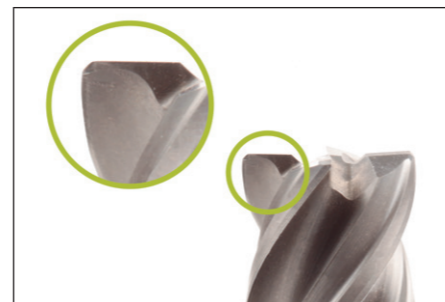

Machining with OCM: Tool after six parts

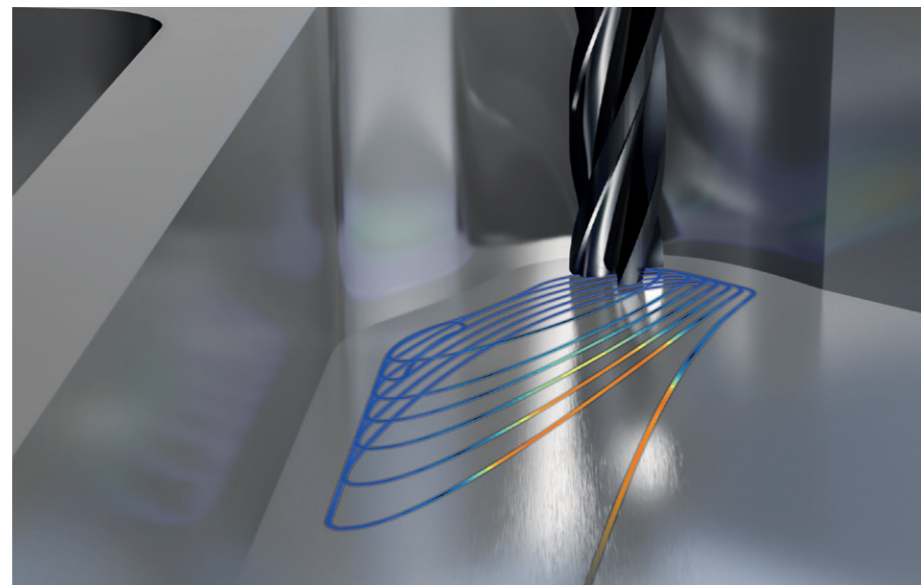

StateMonitor collects and visualizes the statuses of production machines. By evaluating important data such as the current machine status, machine messages, override positions, and utilization history, StateMonitor provides in-depth information about the machine's degree of utilization. Based on the data it collects, StateMonitor also reveals machine-specific optimization potential. The user can enter comments about machine downtimes and setup times in order to uncover machine-specific and organizational optimization potential. Through its messenger function, StateMonitor notifies the appropriate employee by e-mail based on customizable combinations of machine signals and statuses.

StateMonitor collects and visualizes the following information from the networked machines:

- Operating modes
- Override positions (spindle, rapid traverse, feed rate)
- Program status and program name, as well as subprograms if applicable
- Program run time
- SIK number and software number
- Machine messages

Active support for production planning with an extensive range of functions for job data collection:

- Create and assign jobs
- Start and terminate jobs
- Plan setup times and interruptions
- Store additional job data, such as number of parts produced

StateMonitor even lets you connect machines with different controls and supports the following protocol types: HEIDENHAIN DNC, OPC UA, MTConnect, and ModbusTCP.

For more information, please contact HEIDENHAIN.

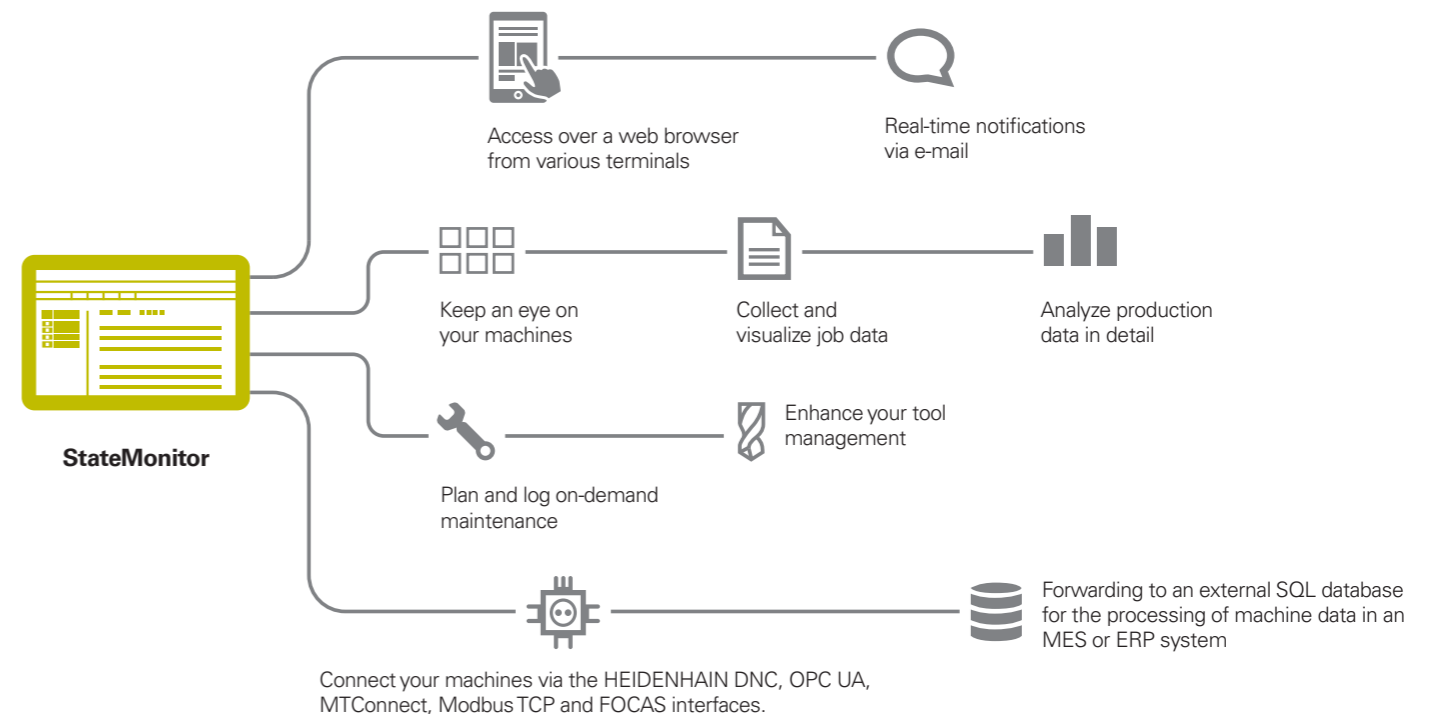
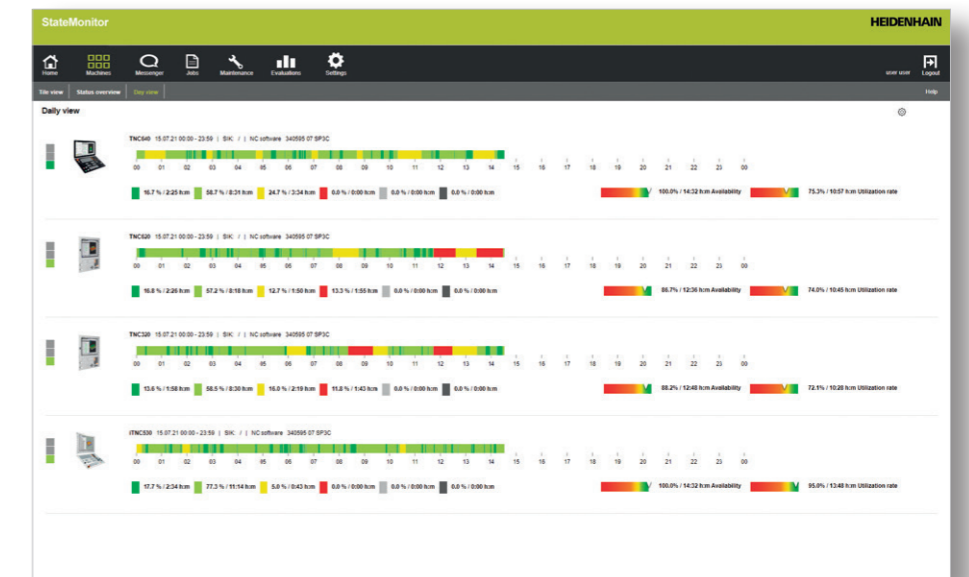



Having a smooth exchange of knowledge is crucial for the success of a company. In order for knowledge to be transferred rapidly and without loss, e-mail communication capability is just as important as the continuous availability of electronic production documents or the transfer of data to ERP and production-activity control systems. Tool and raw material inventories, tool data, workholding drawings, CAD data, NC programs and inspection instructions must all be available to machine users during all shifts. Cost-effective manufacturing therefore requires an efficient process chain and a networked control.

With its Connected Machining package of functions, the TNC 620 control integrates itself flexibly into your process chain and helps you optimize the transfer of knowledge within your company. So let your shop benefit from all of the information available in your company. Connected Machining makes fully digital job management possible in networked manufacturing. You thus benefit from the following:

- Ease of data usage
- Time-saving procedures
- Transparent processes

The networked TNC 620

With the functions of Connected Machining, integrate the TNC 620 into your corporate network, and connect the shop floor via the control to PCs, programming stations, and other data storage media in the following areas:

- Design
- Programming
- Simulation
- Production planning
- Production

Even the standard version of the TNC 620 is equipped with two Gigabit Ethernet ports of the latest generation. The TNC 620 uses the TCP/IP protocol to communicate with NFS servers and Windows networks without needing additional software. The fast data transfer of up to 1000 Mbit/s ensures very short transmission times. The TNC 620 thus offers the optimal technological foundation for Connected Machining, the networking of the control in the shop with all production-related areas in your company.

Standard range of functions

In order to be able to use the data that you have transmitted to the control via your network, the TNC 620 offers several interesting applications, even in its standard range of functions. CAD Viewer, a PDF viewer and the Mozilla Firefox web browser enable the simplest form of Connected Machining: access to manufacturing process data right at the control. In this case, operating web-based documentation systems or ERP systems is just as feasible as accessing your e-mail inbox. For example, the following file formats can also be opened directly on the TNC 620:

- Text and PDF files
- Graphics files with the extensions .gif, .bmp, .jpg, or .png
- Spreadsheet files with the extensions .xls, .xlsx, .odv or .csv
- html files: .htm, .html, .chm and several more

Data transmission

Another solution for full digital job management with Connected Machining is the free-of-charge TNCremo PC software. With it, you can transfer remotely stored part programs and pallet tables in both directions over the Ethernet.

With the powerful TNCremoPlus PC software, you can also transfer the screen contents from the control to your PC using the live-screen function.

Job-related data

With the Remote Desktop Manager software option, you can operate a Windows PC from the TNC 620. On the control, you gain direct access to IT systems within the process chain and make your machine setup processes significantly more efficient by reducing inconvenient legwork between the machine and the office. Technical drawings, CAD data, NC programs, tool data, work instructions, parts lists, and warehouse information are digitally available at the machine. E-mails can be sent and received with ease. With a simple keystroke on the machine operating panel, you can switch between the control screen and the screen of the Windows PC. This PC can be a computer in the local network or an industrial PC (IPC) in the machine's electrical cabinet.

Detailed data for the optimal organization of the production process

HEIDENHAIN DNC enables the connection of existing machine tools to Windows-based industrial applications, meaning that even older TNC controls, like the TNC 426/430 or the iTNC 530, can be connected to modern inventory management systems and production-activity control systems. Use RemoTools SDK to connect your applications to TNC controls, or purchase an application that is DNC-compatible.

Appropriate monitoring and controlling of applications

Efficient and secure digital communication in a machine-tool context requires standardized components, application-relevant information models and adherence to current IT security guidelines. OPC UA NC Server offers an interface based on OPC UA for HEIDENHAIN controls. This internationally standardized and widespread communication protocol makes it fast and easy to connect machines to your production IT network.



You also save time when integrating new functions because the application-based presentation of information considerably reduces programming and configuration effort.

- *State-of-the-art IT security:* Authentication, authorization and cryptography
- *Uncomplicated:* Guided connection configuration
- *Application-oriented:* Tailored to the demands of modern industrial applications
- *Standardized:* OPC UA is the communication technology recommended for Industry 4.0
- *Freedom of choice:* Open selection of operating system and toolkit
- *Virtual testing environment:* Free HEIDENHAIN programming station
- *Expandable by the machine manufacturer:* The machine manufacturer can also enhance the OPC UA NC Server, giving you access to additional sensors, machine subsystems, or values from PLC programs.

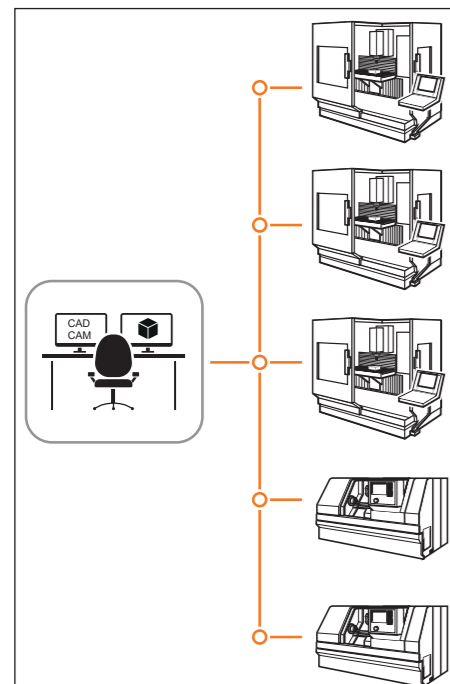

Open to outside information

Processing CAD files with the TNC 620

CAD Viewer

With the standardly available CAD Viewer software, you can open 3D CAD models and drawings directly on the TNC 620. Various view options as well as rotation and zoom capabilities allow for a detailed visual inspection and analysis of your CAD data. You can also use the viewer to ascertain position values from a 3D model. You simply select an arbitrary reference point in your drawing and select the desired contour elements. CAD Viewer then displays the coordinates of the elements in a window. CAD Viewer can depict the following file formats:

- STEP files (.STP and .STEP)
- IGES files (.IGS and .IGES)
- DXF files (.DXF)
- STL files (.STL)

CAD Import (option)

Why program complex contours if you already have the drawing as a DXF, STEP, STL or IGES file? After all, you have the ability to extract contours or machining positions from these types of CAD files. This not only saves time otherwise spent on programming and testing, but you can also be sure that the finished contour is exactly in accordance with the design engineer's specifications.

Extracting machining information directly from CAD data offers additional possibilities, particularly for the creation of NC programs with a tilted machining plane. You can also define the preset with a 3D basic rotation of the 3D model and set a datum with the appropriate 3D rotation in the desired working plane.

You can easily save the working plane to the clipboard and transfer it to the NC program with the appropriate transformation and the associated PLANE command. In the defined working plane, you can extract contours and machining positions, and apply them to the NC program.

Selecting contours is very convenient: Start by selecting any element. Once you select a second element, the TNC detects your desired machining direction and initiates automatic contour detection. In doing so, the TNC automatically selects all clearly identifiable contour elements until the contour closes or branches out. In this manner, you can define extensive contours with just a few steps. Then you can simply copy the selected contour to an existing Klartext program using the clipboard. The contours are output as blocks with linear and circular commands.

You can also select machining positions and save them as point files, especially in order to apply hole positions or starting points for pocket machining. This can be done very easily by selecting the desired area. In a pop-up window with a filter function, the TNC displays all of the hole diameters within the area you have selected. To select the desired hole diameters and restrict the number of hole positions, simply select the corresponding filter symbol to change the filter limits. A zoom function and various configuration possibilities round out the functionality of CAD Import.

It is also possible to define the contour program's resolution for using it in older TNC controls. You can also define a transition tolerance if the contour elements are not completely connected.

The following positions can be defined as presets:

- The beginning, end, or mid-point of a line
- The beginning, end, or center point of a circular arc
- Quadrant transitions or center point of a circle
- Intersection of two lines, including in their extension
- Intersection of a line and a circular arc
- Intersection of a line and a circle

If multiple intersections between two elements are possible (e.g., between a straight line and a circle), you can then select the correct intersection.

Generating STL files (option)

The CAD Model Optimizer software option makes it possible to generate STL files from 3D models. The TNC 620 covers the 3D model displayed in CAD Viewer with a mesh of triangles. This simplifies the original model and removes errors, such as small holes in a solid or self-intersections of a surface. The TNC 620 then generates an STL file that you can use for various functions of the control. For example, you can then easily repair faulty files of fixtures or tool holders.

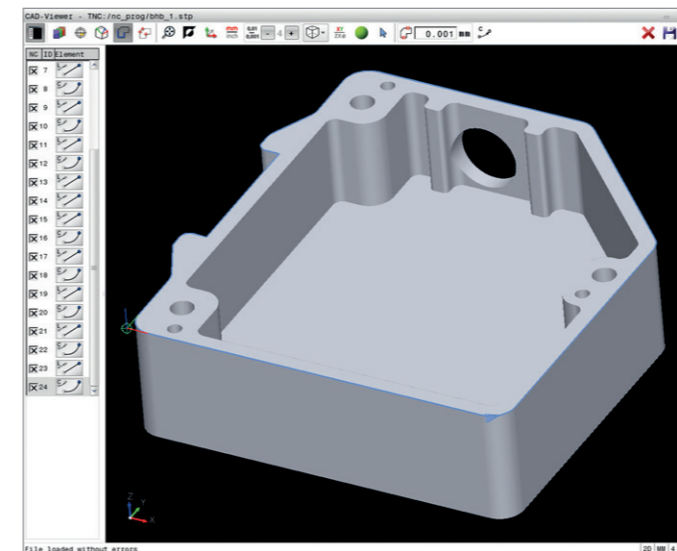
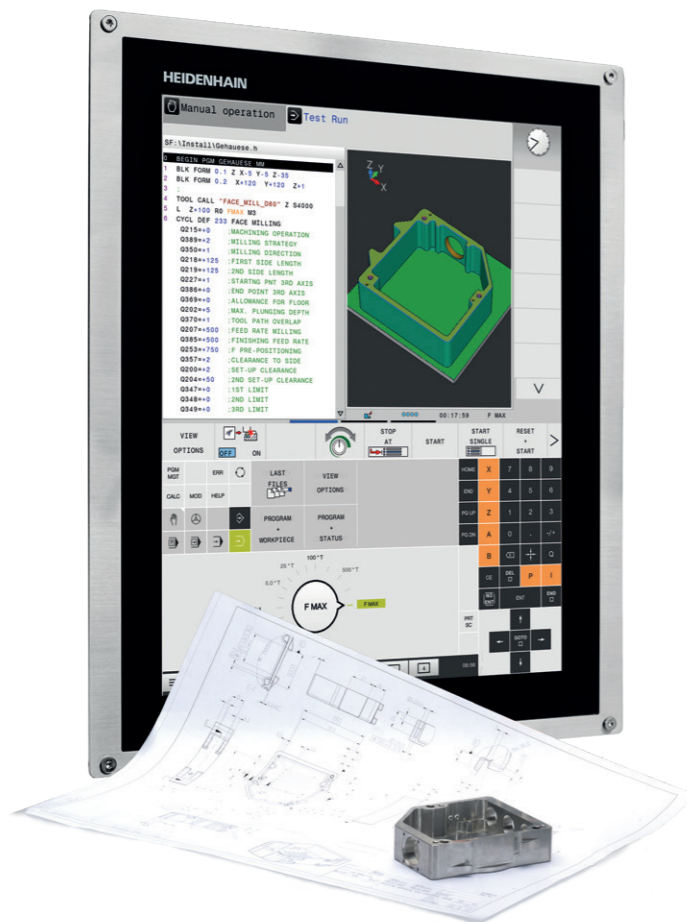

Part program on the basis of the imported DXF file

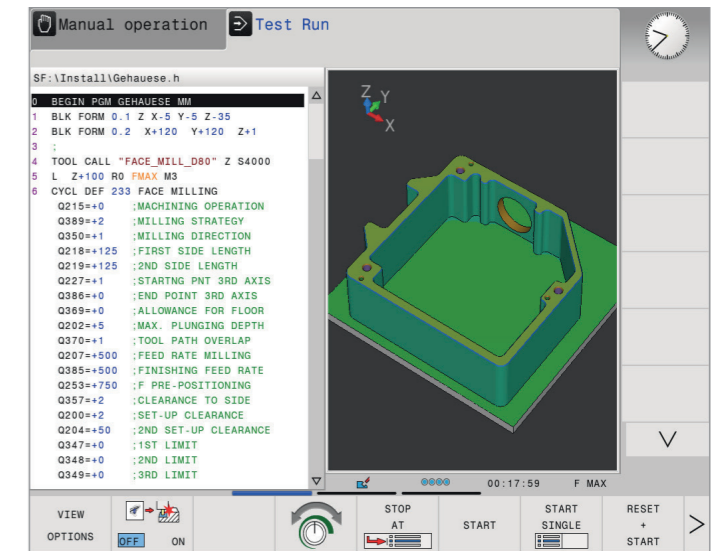

Display of a 3D model in CAD Viewer

What's the purpose of a programming station?

As easy as it is to write a part program on a TNC 620 at the machine while a different part is being machined, short reloading times or high machine utilization may hinder attentive programming work on the shop floor. The TNC 620 programming station lets you program exactly as you would at the machine, but away from all the noise and distractions of the shop floor.

Creating programs

The programming, testing, and optimizing of HEIDENHAIN Klartext or ISO programs with the programming station substantially reduces machine idle times. This is easy to get used to, since every keystroke feels the same. With the programming station, you program using the same keyboard layout that you use at the machine.

Testing programs created offline

Naturally, you can also test programs that were written on a CAD/CAM system. The various views of the program verification graphics help you easily spot contour damage and hidden details.

Training with the programming station

Because the TNC 620 programming station is based on the same software as the TNC 620 control, it is ideally suited for apprentice- and advanced-level training. Programming is performed on the original keyboard unit, and even the test run feature runs exactly as it would on the machine. This gives the trainee the experience needed to safely work on the real machine.

By being programmable in either Klartext or ISO, the TNC 620 programming station is also well suited for TNC programming training in school settings.

Your workstation

The programming station software runs on a PC. The PC screen shows you the same TNC user interface as the control and offers the familiar graphical support. Depending on the version of the programming station, there are multiple ways of using it.

The free demo version contains all of the TNC 620's functions and allows short programs to be saved. Programming is performed on the PC keyboard.

The version with a TNC operating panel lets you create programs in the accustomed manner on a keyboard featuring the same function keys as the control on the machine. It also has a PC keyboard for ISO programming, file names, and comments.

You can also work without the TNC operating panel: a virtual keyboard for operating the programming station is shown on the PC screen. This virtual keyboard provides the TNC 620's most important dialog-opening keys.



Further information:

Comprehensive descriptions of the programming station and a free demo version are available on the Internet at www.heidenhain.com/programming-stations.

Positioning with an electronic handwheel

Fine motion control of axes

You can set up the workpiece by manually jogging the axes with the axis direction keys, but this task is easier and more finely controllable with the electronic handwheels from HEIDENHAIN.

In this method, the axis slides are moved by the feed motor in accordance with the handwheel's rotation. For particularly high sensitivity, you can incrementally set the amount of traversing distance for each handwheel rotation.

Panel-mounted handwheel

The HR 130 panel-mounted handwheel from HEIDENHAIN can be integrated into the machine operating panel or mounted to a different part of the machine.

Portable handwheels

The HR 510, HR 520, and HR 550 portable handwheels are particularly helpful when you work in close proximity to the machine's working space. The axis keys and certain function keys are integrated in the housing. This lets you set up the machine or switch between the axes you want to move from wherever you happen to be standing with the handwheel. As a wireless handwheel, the HR 550 is ideal for use on large machines. If you no longer need the handwheel, simply attach it to the machine using its built-in magnets.

Expanded range of functions of the HR 520 and HR 550

- Definable traversing distance per revolution
- Display for operating mode, actual position value, programmed feed rate, handwheel offset, spindle speed, and error messages
- Override potentiometers for feed rate, handwheel offset, and spindle speed
- Selection of axes by means of keys and soft keys
- Keys for continuous traverse of the axes
- Emergency stop button
- Actual position capture
- NC Start/Stop
- Spindle on/off
- Soft keys for machine functions defined by the machine manufacturer



Workpiece measurement

Setup, preset setting, and measuring with touch trigger probes

Workpiece touch probes* from HEIDENHAIN help you keep costs down in the shop and in serial production: when used in conjunction with the TNC 620, they enable the automated execution of setup, measurement, and inspection functions.

Upon contact with the workpiece surface, the stylus of a TS touch trigger probe is deflected. In that instant, the TS generates a triggering signal that, depending on the model, is transmitted to the control either by cable or by radio or infrared transmission.

The touch probes are inserted directly into the machine tool spindle and can be equipped with various taper shanks depending on the machine. The ball tips, which are made of ruby, are available in different diameters with various stylus lengths.

* The control must be adapted for these functions by the machine manufacturer.



TS 460

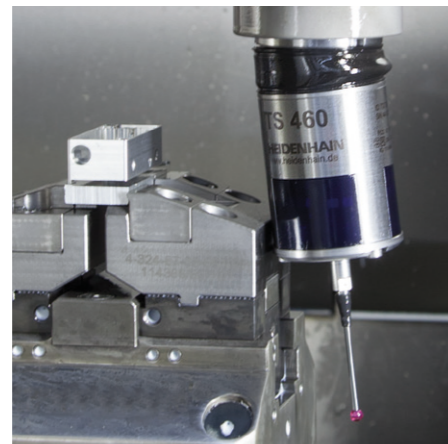

TS 460 with collision protection

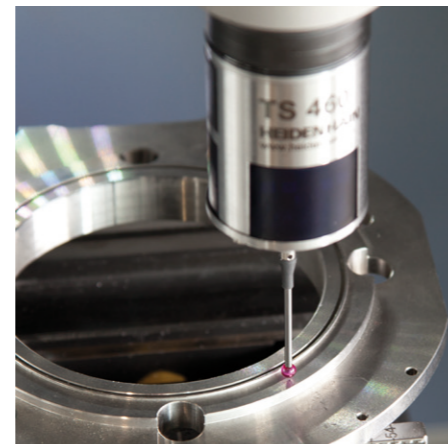

Cable-bound touch probes

For machines requiring manual tool changes, as well as for grinding machines and lathes:

TS 260

- Axial or radial cable connection
- High scanning accuracy

Wireless touch probes

For machines with an automatic tool changer:

TS 460

- Standard touch probe for radio and infrared transmission
- Compact dimensions
- Energy-saving mode
- Optional collision protection
- Thermal decoupling

TS 642

- Activation via switch in taper shank
- Infrared transmission

TS 760

- High scanning accuracy
- High reproducibility
- Low probing forces
- Radio and infrared transmission

Transceiver

Radio or infrared transmission is established between the TS or TT touch probe and the SE transceiver:

SE 660

- For radio or infrared transmission (hybrid technology)
- Same SE for TS 460 and TT 460

SE 661

- For radio or infrared transmission (hybrid technology)
- Same SE for TS 460 and TT 460
- EnDat functionality for transmission of the switching state, diagnostics, and additional information



SE 660

Tool measurement

Measuring length, radius, and wear inside the machine

A key factor in obtaining consistently high production quality is, of course, the tool. This requires exact measurement of the tool dimensions and periodic inspection of the tool for breakage, wear and tooth shape. For tool measurement, HEIDENHAIN offers the TT triggering tool touch probes.

These touch probes are installed directly within the machine's workspace, where they enable tool measurement either before machining or during interruptions.

The TT tool touch probes measure the tool length and radius. During probing of the rotating or stationary tool, such as for individual tooth measurement, the contact plate is deflected and a trigger signal is transmitted directly to the TNC 620.

The TT 160 uses cable-bound signal transmission, whereas the TT 460 sends its signals via radio or infrared transmission. It is thus particularly well suited for use on rotary/tilting tables.

To prevent limiting the machining space and to avoid collisions, the TT touch probe must occasionally be removed from the machine. The touch probe's new magnetic base features three contact points and a setting screw. As a result, the touch probe requires calibration only during initial installation and can then be re-installed and removed with a quick hand movement.

Here are the benefits in a nutshell:

- Fast re-installation without recalibration
- Low-profile base
- Same accuracy as a permanent installation



TT 460



Further information:

You can find detailed descriptions of workpiece touch probes on the Internet at www.heidenhain.com or in the *Touch Probes for Machine Tools* brochure.

Further information:

You can find detailed descriptions of tool touch probes on the Internet at www.heidenhain.com or in the *Touch Probes for Machine Tools* brochure.

Inspecting and optimizing machine accuracy

Easy calibration of rotary axes with KinematicsOpt (option)

Accuracy demands are on the rise, particularly in the realm of 5-axis machining. Complex parts must be manufactured with both precision and reproducible accuracy, including over extended periods of time.

The KinematicsOpt software option for TNC controls is a key ingredient in helping you meet these high demands. First, a cycle automatically measures your machine's rotary axes with a HEIDENHAIN touch probe. The measuring process is the same, regardless of whether the rotary axis is a rotary table, tilting table, or a swivel head.

For calibrating the rotary axes, a calibration sphere is mounted at any position on the machine table and probed with the HEIDENHAIN touch probe. Prior to this, you define the resolution of the measurement and the range that you want to measure for each rotary axis.

Based on the measured values, the TNC calculates the static tilting accuracy. The software minimizes the spatial error arising from the tilting movements and, at the end of the measuring process, automatically saves the machine geometry in the respective machine constants of the kinematics description.

Of course, a detailed log file is also available in which the measured and optimized dispersion (measure of the static tilting accuracy) is saved along with the actual measured values and the actual compensation values.

Optimal use of KinematicsOpt requires a highly rigid calibration sphere for reducing the deformations caused by probing forces. For this purpose, HEIDENHAIN offers calibration spheres with highly rigid holders of various lengths.

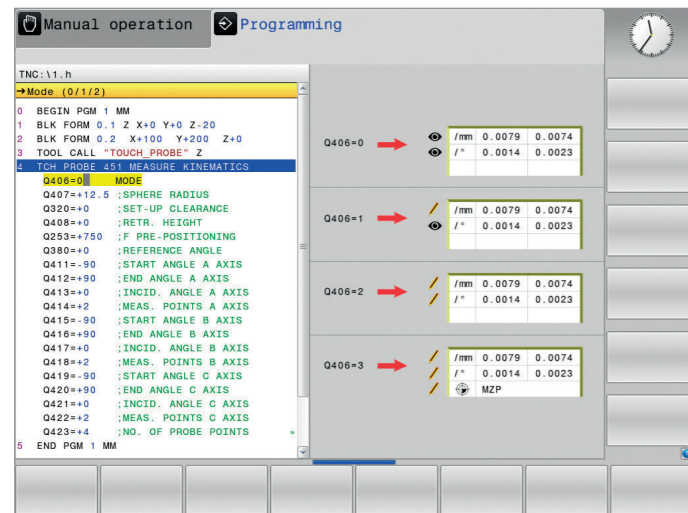

Overview

User functions

User function	Standard	Option	
Short description	✓	0/1	Basic version: 3 axes plus closed-loop spindle 1st or 2nd additional axis for 4 or 5 axes plus spindle Digital current and speed control
Program entry	✓	42	HEIDENHAIN Klartext format ISO (with integrated operating panel: via soft keys or external standard USB keyboard; with separate operating panel: via ASCII keyboard) Importing of contours or machining positions from CAD files (STP, IGS, DXF) and saving them as a Klartext contour program or Klartext point table
Position feedback	✓		Nominal positions for lines and arcs in Cartesian coordinates or polar coordinates Incremental or absolute dimensions Display and entry in mm or inches
Tool compensation	✓	21 9	Tool radius in the working plane, and tool length Radius compensated contour look ahead for up to 99 blocks (M120) Three-dimensional tool-radius compensation for changing tool data without having to recalculate an existing program
Tool tables	✓		Multiple tool tables with any number of tools
Cutting data	✓	167	Automatic calculation of spindle speed, cutting speed, feed per tooth, and feed per revolution OCM: automatic calculation of overlap factor, milling feed rate, spindle speed, climb or up-cut milling, lateral infeed, cutting speed, material removal rate, recommended cooling
Constant contour speed	✓		With respect to the path of the tool center With respect to the cutting edge
Parallel operation	✓		Program creation with graphical support while another program is running
3D machining	✓	9 9 9 9 9	Motion control with highly smoothed jerk 3D tool compensation via surface-normal vectors Changing the swivel-head angle with the electronic handwheel during program run without affecting the tool tip position (TCPM = Tool Center Point Management) Keeping the tool perpendicular to the contour Tool radius compensation perpendicular to the tool direction Manual traverse in the active tool-axis system
Machining with a rotary table		8 8	Programming of cylindrical contours as if in two axes Feed rate in mm/min
Contour elements	✓		Straight line Chamfer Circular path Circle center Circle radius Tangentially connected arc Corner rounding
Contour approach and departure	✓		Approach and departure on a straight line: tangential or perpendicular Approach and departure on an arc
Free contour programming		19	FK free contour programming in HEIDENHAIN Klartext format with graphical support for workpiece drawings not dimensioned for NC

User functions

User function	Standard	Option	
Program jumps	✓ ✓ ✓		Subprograms Program section repeat Any desired program as subprogram
Machining cycles	✓	19 19 19 19 19 19 19 19 19 19 19 19 167	Drilling, tapping (with or without floating tap holder), rectangular and circular pockets Peck drilling, reaming, boring, counterboring, centering Milling internal and external threads Clearing level and oblique surfaces Complete machining of rectangular and circular pockets, rectangular and circular studs Multi-operation machining of straight and circular slots Point pattern: Data Matrix code Contour train, contour pocket Contour slot with trochoidal milling Engraving cycle: engrave text or numbers in a straight line or on an arc OEM cycles (special cycles developed by the machine manufacturer) can be integrated Optimized Contour Milling (OCM) cycles: optimization of roughing processes
Coordinate transformation	✓	8	Shifting, rotating, mirroring, scaling (axis-specific) Tilting the working plane, PLANE function
Q parameters Programming with variables	✓ ✓ ✓ ✓ ✓ ✓		Mathematical functions =, +, -, *, /, sin α, cos α, tan α, arc sin, arc cos, arc tan, a ⁿ , e ⁿ , ln, log, √a, √a ² + b ² Logical operations (=, ≠, <, >) Calculating with parentheses Absolute value of a number, constant π, negation, truncation of digits before or after the decimal point Functions for calculation of circles Functions for text processing
Programming aids	✓ ✓ ✓ ✓ ✓ ✓		Calculator Complete list of all current error messages Context-sensitive help function for error messages TNCguide: the integrated help system; user information available directly on the TNC 620 Graphic support for the programming of cycles Comment and structure blocks in the NC program
Teach-In	✓		Actual positions can be transferred directly to the NC program
Program verification graphics Display modes		20 20 20	Graphical simulation of the machining operation, even while another program is being executed Plan view / projection in three planes / 3D view, also in tilted working plane / 3D line graphics Detail enlargement
Programming graphics	✓		In the Programming mode, the contours of entered NC blocks are rendered (2D pencil-trace graphics), even while another program is running
Program-run graphics Display modes		20 20	Real-time graphical simulation during execution of the milling program Plan view / view in three planes / 3D view
Machining time	✓ ✓		Calculation of machining time in the Test Run mode of operation Display of the current machining time in the program run
Returning to the contour	✓ ✓		Mid-program startup at any block in the program and movement to the calculated nominal position for continuation of the machining operation Program interruption, contour departure and return
Preset management	✓		One table for saving any reference points (presets)

User functions and accessories

User function	Standard	Option	
Datum tables	✓		Multiple datum tables for storing workpiece-specific datums
Pallet tables	✓	154	Workpiece-oriented execution of pallet tables (with any number of entries for the selection of pallets, NC programs, and datums) Production process planning with Batch Process Manager
Touch probe cycles*		17 17 17 17 48	Touch probe calibration Manual or automatic compensation of workpiece misalignment Manual or automatic preset setting Automatic tool and workpiece measurement KinematicsOpt: automatic measurement and optimization of the machine's kinematic model
Parallel secondary axes	✓ ✓ ✓		Compensation of movement in the secondary axes U, V, W through the principal axes X, Y, Z Movements of parallel axes included in the position display of the associated principal axis (sum display) Defining the principal and secondary axes in the NC program enables execution on different machine configurations
Conversational languages	✓		English, German, Czech, French, Italian, Spanish, Portuguese, Swedish, Danish, Finnish, Dutch, Polish, Hungarian, Russian (Cyrillic), Chinese (traditional, simplified), Slovenian, Slovak, Norwegian, Korean, Turkish, Romanian
CAD viewer	✓		Display of standardized CAD file formats on the TNC

* Automatically enabled for HEIDENHAIN touch probes.

Accessories	
Electronic handwheels	<ul style="list-style-type: none"> • HR 510/HR 520 portable handwheels • HR 550 portable wireless handwheel • HR 130 panel-mounted handwheel
Workpiece measurement	<ul style="list-style-type: none"> • TS 260 workpiece touch probe with cable connection • TS 460/TS 760 workpiece touch probes with radio or infrared transmission • TS 642 workpiece touch probe with infrared transmission
Tool measurement	<ul style="list-style-type: none"> • TT 160 triggering tool touch probe • TT 460 triggering tool touch probe with radio or infrared transmission
Programming station	Control software for PCs for programming, archiving, and training <ul style="list-style-type: none"> • Single-station license with original control operating panel • Single-station license with operation via virtual keyboard • Network license with operation via virtual keyboard • Demo version (operated with PC keyboard—free of charge)
Software for PCs	<ul style="list-style-type: none"> • RemoteAccess for remote diagnostics, monitoring, and operation • CycleDesign for creating your own cycle structure • TNCremo for data transfer—free of charge • TNCremoPlus for data transfer with live-screen function • StateMonitor for recording, evaluating, and visualizing machine data

Software options

Option number	Option	With NC software 81776x- and later	
0 to 3	Control Loop Qty.	01	Additional control loop
8	Adv. Function Set 1	01	Rotary table machining <ul style="list-style-type: none"> • Programming of cylindrical contours as if in two axes • Feed rate in mm/min Interpolation: circular in three axes with tilted working plane Coordinate conversion: tilting the working plane, and the PLANE function
9	Adv. Function Set 2	01	Interpolation: straight line in more than four axes (export license required) 3D machining <ul style="list-style-type: none"> • 3D tool compensation via surface normal vectors • Changing the swivel head angle via the electronic handwheel during program run without changing the position of the tool center point (TCPM = Tool Center Point Management); only with the Adv. Function Set 3 software option • Keeping the tool perpendicular to the contour • Tool radius compensation perpendicular to the tool direction • Manual traverse in the active tool-axis system
17	Touch Probe Functions	01	Touch probe cycles <ul style="list-style-type: none"> • Workpiece misalignment compensation, preset setting • Automatic tool and workpiece measurement • Touch probe input enabled for non-HEIDENHAIN touch probes
18	HEIDENHAIN DNC	01	Communication with external PC applications over COM component
19	Adv. Programming Features	01	FK free contour programming Canned cycles <ul style="list-style-type: none"> • Peck drilling, reaming, boring, counterboring, centering • Milling internal and external threads • Clearing level and oblique surfaces • Multi-operation machining of straight and circular slots • Multi-operation machining of rectangular and circular pockets • Cartesian and polar point patterns and point patterns for DataMatrix code • Contour train, contour pocket—also with contour-parallel machining • Contour slot with trochoidal milling • Special cycles developed by the machine manufacturer can be integrated
20	Advanced Graphic Features	01	Program-verification graphics, program-run graphics Plan view, projection in three planes, 3D view, 3D line graphic
21	Adv. Function Set 3	01	Tool compensation <ul style="list-style-type: none"> • Radius-compensated contour look-ahead for up to 99 blocks (LOOK AHEAD) 3D machining <ul style="list-style-type: none"> • Superimposing handwheel positioning during program run
24	Gantry Axes	01	Gantry axes via master-slave torque control
42	CAD Import	05	Importing of contours from 3D and 2D models (e.g., STEP, IGES, DXF)
46	Python OEM Process	01	Execution of Python application
48	KinematicsOpt	01	Touch-probe cycles for the automatic measurement of rotary axes
49	Double Speed Axes	01	Short control-loop cycle times for a direct drive motor

Option number	Option	With NC software 81776x- and later	
56 to 61	OPC UA NC Server	08	Reliable and stable interface for the connection of state-of-the-art industry applications; uncomplicated thanks to the use of standardized designs. Each of the six SIK options enables an incoming OPC UA connection via an application certificate
93	Ext. Tool Management	02	Extended tool management <ul style="list-style-type: none"> • Tooling list (list of all tools of the NC program) • T usage sequence (sequence of all tools inserted during the program)
133	Remote Desk. Manager	01	Display and operation of external computer units (e.g., a Windows PC)
141	Cross Talk Comp.	01	CTC: compensation of axis couplings
142	Position Adapt. Contr.	01	PAC: position-dependent adaptation of the control parameters
143	Load Adapt. Contr.	01	LAC: load-dependent adaptation of the control parameters
144	Motion Adapt. Contr.	01	MAC: motion-dependent adaptation of the control parameters
145	Active Chatter Contr.	01	ACC: active suppression of chatter during heavy machining
146	Machine Vibr. Contr.	08	Damping of machine oscillations to improve workpiece surfaces. The following functions are part of Machine Vibration Control (MVC): <ul style="list-style-type: none"> • Active Vibration Damping (AVD): active damping of vibrations in the control loop • Frequency Shaping Control (FSC): reduction of vibration inducement by means of frequency-based feedforward control
152	CAD Model Optimizer	16	Conversion and optimization of CAD models <ul style="list-style-type: none"> • Fixtures • Workpiece blank • Finished part
154	Batch Process Mngr.	05	Batch Process Manager for easy planning and execution of multiple production jobs
155	Component Monitoring	06	Monitoring for component overloading and wear
160	Integrated FS: Basic	07	Gen 3 exclusive: <ul style="list-style-type: none"> • Enables 4 safe control loops • Enabling of functional safety (FS)
161	Integrated FS: Full	07	Gen 3 exclusive: <ul style="list-style-type: none"> • Enables the maximum number of safe control loops • Enabling of functional safety (FS)
162 to 166	FS Control Loop Qty.	07	Additional safe control loop 1 to 5
167	Opt. Contour Milling	07	Enhance clearing processes
169	FS Control Loop Qty.	08	Enabling of all FS axis options or control loops. The software options Integrated FS: Basic as well as FS Control Loop Qty. (162 to 166) must already be set.

Specifications	Standard	Option	
Components	✓		MC main computer 19-inch portrait screen (1024 x 1280 pixels) for multitouch operation 15-inch screen (1024 x 768 pixels)
Operating system	✓		HEROS 5 real-time operating system for machine control
NC program memory	✓		CFR: 7.7 GB (total capacity: 30 GB)
Input resolution and display step	✓		Linear axes: down to 0.01 µm Rotary axes: down to 0.00001°
Interpolation	✓	9	Linear in 4 axes Linear in up to 5 axes (export license required)
	✓	8	Circular in 2 axes Circular in 3 axes with tilted working plane
	✓		Helical: superimposition of circular and straight paths
Block processing time	✓		1.5 ms (3D straight line without radius compensation)
Axis feedback control	✓		Position-loop resolution: signal period of the position encoder/4096
	✓		Cycle time of position controller: 200 µs (100 µs with the Double Speed Axes software option)
Error compensation	✓		Linear and nonlinear axis error, backlash, reversal peaks during circular movements, reversal error, thermal expansion
	✓		Static friction, sliding friction
Data interfaces	✓		Network interface for remote operation of the TNC using the TNCremo or TNCremoPlus software from HEIDENHAIN
	✓		2 x Ethernet interface, 1 Gigabit
	✓		USB 3.0 (and one USB 2.0 on the operating panel); the number of ports depends on the hardware used
		18	HEIDENHAIN-DNC for communication between a Windows application and the TNC (DCOM interface)
		56-61	OPC UA NC Server Secure and reliable interface for connecting leading-edge industrial applications
Diagnostics	✓		Fast and simple troubleshooting through integrated diagnostic aids
Ambient temperature	✓		Operation: +5 °C to +40 °C
	✓		Storage: -20 °C to +60 °C

Control	TNC 620 NC software 81760x-18	TNC 640 NC software 34059x-18
Area of application	Standard milling	High-end milling/turning/grinding
Simple machining centers (up to 8 control loops, max. 2 of which are spindles)	✓	✓
Machine tools / machining centers (up to 24 control loops, max. 4 of which are spindles)	-	✓
Milling/turning/grinding operations (up to 18 control loops + 2 spindles)	-	Option
Program entry		
HEIDENHAIN Klartext	✓	✓
ISO programming	✓	✓
CAD Import	Option	Option
CAD Viewer	✓	✓
FK free contour programming	Option	✓
Extended milling and drilling cycles	Option	✓
OCM cycles	Option	Option
Turning cycles	-	Option
Functions for grinding	-	Option
NC program memory	CFR: 7.7 GB (total capacity: 30 GB)	• HDR: 285 GB (total capacity: 320 GB) • SSDR: 17 GB (total capacity: 32 GB)
5-axis and high-speed machining	Option	Option
Block processing time	1.5 ms	< 0.5 ms
Input resolution and display step (standard)	0.01 µm	0.01 µm
Screen and keyboard	15-inch touchscreen/ 19-inch touchscreen (portrait)	19-inch / 24-inch touchscreen
Touchscreen	✓	✓
Adaptive Feed Control (AFC)	-	Option
Active Chatter Control (ACC)	Option	Option
Dynamic Collision Monitoring (DCM)	-	Option
Fixture monitoring	-	Option
KinematicsOpt	Option	Option
KinematicsComp	-	Option
Touch probe cycles	Option	✓
Pallet management	✓	✓
Parallel axis function	✓	✓

✓ Standard
- Not available

HEIDENHAIN

Mastering nanometer accuracy



HEIDENHAIN

DR. JOHANNES HEIDENHAIN GmbH
Dr.-Johannes-Heidenhain-Straße 5
83301 Traunreut, Germany
☎ +49 8669 31-0
☎ +49 8669 32-5061
info@heidenhain.de
www.heidenhain.com



HEIDENHAIN
worldwide