



HEIDENHAIN



CNC PILOT 640

The Contouring Control for
Lathes and Turning-Milling
Machines

Information for the
Machine Tool Builder

Contouring control

General information

- CNC PILOT 640**
- Contouring control for **lathes, turning-milling machines and high-performance turning centers**
 - Suitable for horizontal and vertical lathes as well as vertical boring and turning mills
 - Axes: max. 24 control loops; max. 8 NC axes per channel; max. 6 spindles in the overall system
 - Up to 3 channels for asynchronous multi-slide machining
 - Up to 3 principal axes (X, Z, and Y), B axis, closed-loop spindle and counter spindle, C1/C2 axis and driven tools
 - 5-axis simultaneous machining (X, Z, Y, B, and C axes)
 - Up to 3 programmable auxiliary axes (U, V, W) for control of steady rest, tailstock and counter spindle
 - The position of a parallel secondary axis can be shown combined with its principal axis
 - For operation with HEIDENHAIN inverter systems and ideally with HEIDENHAIN motors
 - Fully digital with HSCI interface and EnDat interface
 - 24-inch or 15.6-inch multitouch screen
 - Storage medium: CFR CompactFlash memory card (CFast)
 - Programming of turning, drilling, and milling operations with smart.Turn, according to DIN, or via cycles
 - TURN PLUS: automated smart.Turn program generation
 - ICP free contour programming for turning and milling contours
 - For simple tool holders (multifix), turrets, or magazines

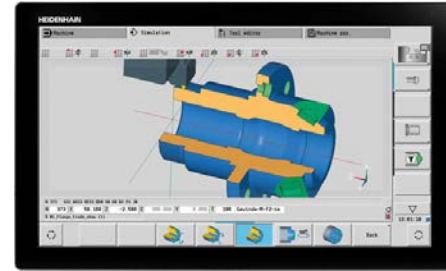

CNC PILOT 640 with 24-inch multitouch screen

System test Controls, power modules, motors, and encoders from HEIDENHAIN are usually integrated as components into complete systems. In such cases, comprehensive testing of the complete system is required, irrespective of the specifications of the individual devices.

Parts subject to wear Controls from HEIDENHAIN contain parts subject to wear, such as a backup battery and fan.

Standards Standards (ISO, EN, etc.) apply only where explicitly stated in the brochure.

Note Intel, Intel Xeon, Core, and Celeron are registered trademarks of Intel Corporation.

Validity The features and specifications described here apply to the following control and NC software versions:

CNC PILOT 640 with NC software versions

- 688946-18 (export license required)
- 688947-18 (no export license required)

This brochure supersedes all previous editions, which thereby become invalid. **Subject to change without notice.**

Requirements Some of these specifications require particular machine configurations. Please also note that, for some functions, a special PLC program must be created by the manufacturer.

Starting with version 68894x-18, the NC software can be installed only in a storage medium with ≥ 30 GB of nominal capacity. Smaller storage media can no longer be used. In addition, the main computer (MC) must be equipped with at least 4 GB of main memory.

Contents

Contouring control	2
Overview tables	4
HSCI control components	16
Accessories	25
Cable overview	44
Technical description	51
Data transfer and communication	78
Mounting information	81
Key dimensions	82
General information	101
Other HEIDENHAIN controls	104
Subject index	107

Please note the page references in the tables with the specifications.

Functional safety (FS)

If standard components and FS components (FS = Functional Safety) are not explicitly differentiated, then the information applies to both versions (e.g., TE 725T, TE 725T FS).

Components for which there is also a version with functional safety bear the identifier "(FS)" at the end of the product designation (e.g., UEC 3xx (FS)).

Using this brochure

This brochure is purely a decision-making aid for selecting HEIDENHAIN components. Further documentation is needed for actual project planning (see "Technical documentation", Page 101).

Overview tables

Components

Control systems		24-inch design	15.6-inch design	Page
Main computer	<i>For operating panel</i>	MC 366 (full HD, 1920 x 1080 pixels)	MC 8420T (1366 x 768 pixels)	16
	<i>For electrical cabinet</i>	MC 306	-	
Multi-touch display		BF 360 (full HD, 1920 x 1080 pixels)	-	22
Keyboard unit		TE 361T TE 361T FS	TE 725T TE 725T FS	21
Machine operating panel		Integrated		
		PLB 6001, PLB 600x FS (HSCI adapter for OEM machine operating panel)		25
Storage medium		CFR memory card		18
NC software license		On SIK component		18
PLC inputs/ outputs¹⁾	With HSCI interface	PL 6000 consisting of PLB 62xx basic module (system PL) or PLB 61xx (expansion PL) and I/O modules		23
		On UEC and UMC		
Additional modules¹⁾		CMA-H for analog axes/spindles in the HSCI system		26
		Modules for fieldbus systems		
Inverter systems²⁾		Compact inverters and modular inverters		
Connecting cables		✓		44

¹⁾ May be necessary depending on the configuration

²⁾ For more information, refer to the *Inverter Systems for Gen 3 Drives* brochure

Please note: The MC main computer does not have any PLC inputs/outputs. Therefore one PL 6000, one UEC, or one UMC is necessary for each control. They feature safety-relevant inputs/outputs as well as the connections for touch probes.

Accessories

Accessory	CNC PILOT 640	Page
Electronic handwheels	<ul style="list-style-type: none"> • HR 510, HR 510 FS portable handwheel • HR 520, HR 520 FS portable handwheel with display • HR 550 FS portable wireless handwheel with display • HR 130 panel-mounted handwheel 	27
Workpiece touch probes¹⁾	<ul style="list-style-type: none"> • TS 460, TS 760 triggering touch probes with radio or infrared transmission • TS 260, TS 750, TS 150 triggering touch probes with cable connection 	
Tool touch probes¹⁾	With cuboid probe contact as accessory <ul style="list-style-type: none"> • TT 160 triggering touch probe • TT 460 triggering touch probe with radio or infrared transmission 	
Programming station²⁾	DataPilot CP 640 Control software for PCs for programming, archiving, and training <ul style="list-style-type: none"> • Full version with single user license or network license • Demo version (free of charge) 	
Auxiliary axis control	PNC 610	32
Industrial PC	ITC 362/ITC 860 additional operating station with touchscreen and integrated screen keyboard ITC 855 additional operating station with touchscreen and ASCII keyboard IPC 306 industrial PC for Windows IPC 6490/IPC 8420 industrial PC for PNC 610	30
Snap-on keys	For controls and handwheels	34

¹⁾ For more information, refer to the *Touch Probes* brochure

²⁾ For more information, refer to the *Programming Station for Turning Controls* brochure

Software tools	CNC PILOT 640	Page
PLCdesign¹⁾	PLC development software	75
TNCremo²⁾, TNCremoPlus²⁾³⁾	Data transfer software (TNCremoPlus with "live" screen)	79
ConfigDesign¹⁾	Software for configuring the machine parameters	70
TNCkeygen¹⁾	Software for enabling SIK options for a limited time, and for single-day access to the OEM area	18
TNCscope¹⁾	Software for data recording	71
TNCopt¹⁾	Software for putting digital control loops into service	71
IOconfig¹⁾	Software for configuring PLC I/O and fieldbus components	24
RemoteAccess¹⁾³⁾	Software for remote diagnostics, monitoring, and operation	72
RemoTools SDK¹⁾	Function library for developing customized applications for communication with HEIDENHAIN controls	80
TNCtest¹⁾	Software for creation and execution of an acceptance test	73
TNCalyzer¹⁾	Software for the analysis and evaluation of service files	73

¹⁾ Available to registered customers for download from the Internet

²⁾ Available to all customers (without registration) for download from the Internet

³⁾ Software release module required

Specifications

Specification	CNC PILOT 640	Page
Axes	Max. 24 control loops max. 8 NC axes per channel; max. 6 spindles in the overall system	57
Axes	Up to 6 closed-loop linear axes X, Z, U, V, W: Standard Y: Option	
B axis	Option	
C1/C2 axis	Option	
Synchronized axes	✓	
PLC axes	✓	
Spindles	Up to 6 controlled spindles: Main spindle Counter spindle Driven tool	60 61
Speed	Max. 60 000 rpm for motors with a single pole pair (with software option 49: max. 120 000 rpm)	60
Operating mode switchover	✓	60
Position-controlled spindle	✓	60
Oriented spindle stop	✓	60
Gear shifting	✓	60
NC program memory	≈ 7.7 GiB	16
Input resolution and display step		57
Linear axes	X axis: 0.5 μm (diameter 1 μm) U, V, W, Y, Z axes: 1 μm	
Rotary axes	B, C1/C2 axis: 0.001°	
Functional safety (FS)	With FS components, SPLC, and SKERN	53
For applications with up to	<ul style="list-style-type: none"> SIL 2 according to EN 61 508 Category 3, PL d as per EN ISO 13 849-1:2008 	
Interpolation		
Straight line	In 2 axes (maximum: ±100 m); in 3 main axes with software option 70	
Circular	In 2 axes (max. radius: 999 m); additional linear interpolation of the third axis with software option 55 or 70	
C1/C2 axis	Interpolation of the linear axes X and Z with the C1/C2 axis (software option 55)	
B axis	5-axis interpolation between the X-, Z-, Y-, B- and C-axis (software option 54)	
Multichannel machining	Up to three channels for asynchronous multi-slide machining (software option 153)	59
Axis feedback control		63
With following error	✓	
With feedforward	✓	
With jerk limiting	✓	57
Maximum feed rate	$\frac{60000 \text{ rpm}}{\text{No. of motor pole pairs}} \cdot \text{Screw pitch [mm]}$ At $f_{\text{PWM}} = 5000 \text{ Hz}$	57
Constant surface speed	✓	

Specification	CNC PILOT 640	Page																		
Input	mm/min or mm/revolution																			
Cycle times of main computer	MC	64																		
Block processing	1.5 ms																			
Cycle times of controller unit	CC/UEC/UMC	64																		
Path interpolation	3 ms	64																		
Fine interpolation	<i>Single-speed:</i> 0.2 ms <i>Double-speed:</i> 0.1 ms (software option 49)																			
Position controller																				
Speed controller																				
Current controller	<table border="0"> <tr> <td>f_{PWM}</td> <td>T_{INT}</td> </tr> <tr> <td>3.333 kHz</td> <td>150 μs</td> </tr> <tr> <td>4 kHz</td> <td>125 μs</td> </tr> <tr> <td>5 kHz</td> <td>100 μs</td> </tr> <tr> <td>6.666 kHz (software option 49)</td> <td>75 μs (software option 49)</td> </tr> <tr> <td>8 kHz (software option 49)</td> <td>62.5 μs (software option 49)</td> </tr> <tr> <td>10 kHz (software option 49)</td> <td>50 μs (software option 49)</td> </tr> <tr> <td>13.333 kHz (software option 49)</td> <td>37.5 μs (software option 49)</td> </tr> <tr> <td>16 kHz (software option 49)</td> <td>31.25 μs (software option 49)</td> </tr> </table>	f_{PWM}	T_{INT}	3.333 kHz	150 μs	4 kHz	125 μs	5 kHz	100 μs	6.666 kHz (software option 49)	75 μs (software option 49)	8 kHz (software option 49)	62.5 μs (software option 49)	10 kHz (software option 49)	50 μs (software option 49)	13.333 kHz (software option 49)	37.5 μs (software option 49)	16 kHz (software option 49)	31.25 μs (software option 49)	
f_{PWM}	T_{INT}																			
3.333 kHz	150 μs																			
4 kHz	125 μs																			
5 kHz	100 μs																			
6.666 kHz (software option 49)	75 μs (software option 49)																			
8 kHz (software option 49)	62.5 μs (software option 49)																			
10 kHz (software option 49)	50 μs (software option 49)																			
13.333 kHz (software option 49)	37.5 μs (software option 49)																			
16 kHz (software option 49)	31.25 μs (software option 49)																			
Permissible temperature range	Operation: In electrical cabinet: 5 °C to 40 °C In operating panel: 0 °C to 50 °C Storage: -20 to 60 °C																			

Interfacing to the machine

Interfacing to the machine	CNC PILOT 640	Page
Error compensation	✓	69
Linear axis error	✓	69
Nonlinear axis error	✓	69
Backlash	✓	69
Reversal spikes during circular movement	✓	69
Hysteresis	✓	69
Thermal expansion	✓	69
Static friction	✓	69
Sliding friction	✓	69
Integrated PLC	✓	74
Program format	List of commands	74
Program input at the control	✓	74
Program input by PC	✓	74
Symbolic PLC-NC interface	✓	74
PLC memory	≈ 4 GiB	74
PLC cycle time	9 ms to 30 ms (adjustable)	74
PLC inputs/outputs	For the maximum configuration of the PLC system, see Page 52	23
PLC inputs, DC 24 V	Via PL, UEC, UMC	23
PLC outputs, DC 24 V	Via PL, UEC, UMC	23
Analog inputs ±10 V	Via PL	23
Inputs for PT 100 thermistors	Via PL	23
Analog outputs ±10 V	Via PL	23
PLC functions	✓	74
PLC soft keys	✓	75
PLC positioning	✓	75
PLC Basic Program	✓	76
Integration of applications		75
High-level language programming	Use of the Python programming language in conjunction with the PLC (software option 46)	75
User interfaces can be custom-designed	Creation of individualized user interfaces by the machine manufacturer with the Python programming language with Qt/QML. Programs up to a memory limit of 10 MB are enabled in standard mode. More can be enabled via software option 46.	75

Interfacing to the machine	CNC PILOT 640	Page
Setup and diagnostic aids		70
TNCdiag	Software for the analysis of status and diagnostic information of digital drive systems	70
TNCopt	Software for putting digital control loops into service	71
ConfigDesign	Software for creating the machine configuration	70
Integrated oscilloscope	✓	70
Trace function	✓	71
API DATA function	✓	71
Table function	✓	71
OLM (online monitor)	✓	71
Log	✓	71
TNCscope	✓	71
Bus diagnostics	✓	73
Data interfaces	✓	
Ethernet	✓	78
USB	✓	78
Protocols		78
Standard data transmission	✓	78
Blockwise data transfer	✓	78

Functions for the user

Function	Standard	Option	CNC PILOT 640
Configuration	✓	0-6 55+0-6 70+0-6 54+0-6 94+0-6 132+0-6	Basic version: X and Z axis, main spindle Driven tool and auxiliary axes (U, V, W) C axis and driven tool Y axis B axis Parallel axes U, V, W (display function and compensation) Counter spindle Digital current and speed control
Operating modes			
Manual operation	✓ ✓	11	Manual slide movement through axis-direction keys, an intermediate switch, or electronic handwheels Graphical support for entering and running cycles without storage of the machining steps, in direct alternation with manual machine operation Thread reworking (thread repair) in a second workpiece setup
Teach-in mode		8	Sequential arrangement of canned cycles, with each cycle being run immediately after input or graphically simulated and subsequently saved
Program run	✓	9 8	All are possible in single-block and full-sequence modes DIN PLUS programs smart.Turn programs Cycle programs
Setup functions	✓ ✓ ✓ ✓ ✓ ✓	17 17 17	Workpiece datum setting Definition of tool-change position Definition of protection zone Definition of machine dimensions Manual programs Tool measurement by touching the workpiece Tool measurement with a TT tool touch probe Tool measurement with an optical gauge Workpiece measurement with a TS workpiece touch probe
Programming			
Cycle programming		8 8 8 8 8 8 8 8 8 8 8+55 8+55 8+55 8+55 8+55 8+55 8 8 8 8+9	Turning cycles for simple or complex contours, and contours described with ICP Contour-parallel turning cycles Recessing cycles for simple or complex contours, and contours described with ICP Repetitions with recessing cycles Recess turning cycles for simple or complex contours, and contours described with ICP Undercut and parting cycles Engraving cycles Threading cycles for single or multi-start longitudinal, taper, or API threads, and threads with variable pitch Cycles for axial and radial drilling, pecking, and tapping operations with the C axis Thread milling with the C axis Axial and radial milling cycles for slots, figures, single surfaces, and centric polygon surfaces, and for complex contours described with ICP for machining with the C axis Helical slot milling (multi-start) with the C axis Deburring of ICP contours Linear and circular patterns for drilling, boring, and milling operations with the C axis Context-sensitive help graphics Transfer of cutting values from the technology database Use of DIN macros in cycle programs Conversion of cycle programs to smart.Turn programs

Function	Standard	Option	CNC PILOT 640
Interactive Contour Programming (ICP)		8/9 8/9 8/9 8/9 8/9 8/9 8/9 8/9 8/9+55 9+70 8/9+55+70+132 8/9+42	Contour definition with linear and circular contour elements Immediate display of entered contour elements Calculation of missing coordinates, intersections, etc. Graphical display of all solutions for selection by the user if more than one solution is possible Chamfers, rounding arcs, and undercuts available as form elements Input of form elements immediately during contour creation or through later superimposition Changes to existing contours can be programmed Machining attributes available for individual contour elements C-axis machining on face and lateral surface: – Description of individual holes and hole patterns (only in smart.Turn) – Description of figures and figure patterns for milling (only in smart.Turn) – Creation of freely definable milling contours Yaxis machining on the XY and ZY planes (only in smart.Turn): – Description of individual holes and hole patterns – Description of figures and figure patterns for milling – Creation of freely definable milling contours Programming of the rear face for full-surface machining with the C and Y axes DXF import: Import of contours for lathe and milling operations
smart.Turn programming		9 9 9 9 9 9 9 9 9+55/70 9+55 9+55/70 9 9 9 9 9 9	The basis is the "unit," which is the complete description of a machining block (geometry, technology and cycle data) Dialog boxes divided into overview and detail forms Fast navigation between the forms and the input groups via the "smart" keys Context-sensitive help graphics Start unit with global settings Transfer of global values from the start unit Transfer of cutting values from the technology database Units for all turning and recessing operations for simple contours and ICP contours Units for boring, drilling, and milling operations with the C or Y axis for holes, milling contours, and drilling and milling patterns that are simple or that have been programmed with ICP Activating/deactivating special units for the C axis; subprograms and section repeats Verification graphics for the workpiece blank and finished part, also for C- and Y-axis contours Turret assignment and other setup information in the smart.Turn program Parallel programming Parallel simulation Trochoidal milling Hobbing Multiple plunging Batch Mode (automatic execution of multiple different main programs)
TURN PLUS	✓	63	Automatic smart.Turn program generation with – Automatic tool selection – Automatic turret assignment – Automatic calculation of cutting data – Automatic generation of machining sequence in all working planes, also for C-axis machining (with option 55) and Y-axis machining (with option 70) – Automatic cutting limitation through chucking equipment – Automatic generation of work blocks for rechucking for turning with counter spindles – Automatic generation of work blocks for rear-face machining (with option 132)

Function	Standard	Option	CNC PILOT 640
DIN PLUS programming	✓		Programming in DIN 66025 format
	✓		Expanded command format (IF ... THEN ... ELSE ...)
	✓		Simplified geometry programming (calculation of missing data)
	✓		Powerful fixed cycles for area clearance, recessing, recess turning, and thread machining
		55	Powerful fixed cycles for drilling and milling with the C axis
		70	Powerful fixed cycles for drilling and milling with the Y axis
	✓		Subprograms
	✓		Technology functions for full-surface machining:
	✓		– Moving to a fixed stop
	✓		– Parting control
		131/132	– Spindle synchronization
		132	– Converting and mirroring
	✓		– Mechatronic tailstock
	✓		Programming with variables
	8/9	Contour description with ICP	
✓		Program verification graphics for workpiece blank and finished part	
✓		Turret assignment and other setup information in the DIN PLUS program	
	9	Conversion of smart.Turn units into DIN PLUS command sequences	
✓		Parallel programming	
✓		Parallel simulation	
Simulation	✓		Graphical simulation of the cycle process, or of the cycle, smart.Turn or DIN PLUS program
	✓		Depiction of the tool paths as pencil-trace or cutting-path graphics; special identification of the rapid traverse paths
	✓		Machining simulation (2D material-removal graphics)
		55	Side or face view or 2D view of cylindrical surface for verification of C-axis machining
	✓		Display of programmed contours
		54	View of the tilted plane (B-axis machining)
	✓		View of front face and YZ plane for verification of Y-axis machining
	✓		Three-dimensional rendering of the workpiece blank and finished part
	132	Simulation of mirrored contours for rear-face machining	
✓		Shifting and magnifying functions	
✓		Block scan in the simulation	
✓		Including for complex multi-channel machining operations	
Program-run graphics	✓		Graphical depiction of the current machining operation
B-axis machining		54	Machining with the B axis
	✓		Tilting the working plane
		54	Rotating the machining position of the tool
	9+54	Simultaneous turning	
Eccentric machining		135	Cycles for eccentric turning and for the manufacture of oval and polygonal contours
		135	Superimpositioning of traversing movements of the X and Y axes synchronously to the rotational motion of the spindle
Machining time analysis	✓		Calculation of machining times and idle times
	✓		Consideration of the switching commands triggered by the CNC
	✓		Representation of time per individual cycle or per tool change
Monitoring functions		151	Load Monitoring: detect tool wear and tool breakage during machining
		155	Component Monitoring: monitor for the overloading and wear of machine components

Function	Standard	Option	CNC PILOT 640
Tool database	✓		For 250 tools
		10	For 999 tools
	✓		Tool description can be entered for every tool
	✓		Automatic inspection of the tool-tip position relative to the machining contour
	✓		Compensation of the tool-tip position in the X/Y/Z plane
	✓		Fine compensation of tool via handwheel with application of compensation values in the tool table
	✓		Automatic tool-tip and cutter radius compensation
	✓		Tool monitoring for lifetime of the insert (tool tip) or the number of workpieces produced
		10	Tool monitoring with automatic tool change after end of tool life
	✓		Management of multipoint tools (multiple inserts or multiple reference points)
✓		Support of quick-change tool systems	
Technology database		8/9	Access to cutting data upon definition of workpiece material, cutting material, and the machining mode. The CNC PILOT 640 distinguishes between 16 machining modes. Each combination of workpiece material and tool material includes the cutting speed, the main feed rate, the secondary feed rate, and the infeed for the 16 machining modes.
		8/9	Automatic determination of the machining modes based on the cycle or the machining unit
		8/9	The cutting data are entered in the cycle or in the unit as suggested values
		8/9	9 combinations of workpiece material and tool material (144 entries)
		10	62 combinations of workpiece material and tool material (992 entries)
User management	✓		Configurable tying of permissions to user roles – Login at the control with a user account – User-specific HOME folder for simplified data management – Role-based access to the control and the network data
Conversational languages	✓		English, German, Czech, French, Italian, Spanish, Portuguese, Dutch, Swedish, Danish, Finnish, Norwegian, Slovenian, Slovak, Polish, Hungarian, Russian (Cyrillic), Romanian, Turkish, Chinese (traditional and simplified), Korean

Software options

Option number	Option	Starting with NC-Software 688946-688947-	ID	Comment	page
0	Additional Axis 1	01	354540-01	Additional control loop 1	20
1	Additional Axis 2	01	353904-01	Additional control loop 2	20
2	Additional Axis 3	01	353905-01	Additional control loop 3	20
3	Additional Axis 4	01	367867-01	Additional control loop 4	20
4	Additional Axis 5	01	367868-01	Additional control loop 5	20
5	Additional Axis 6	01	370291-01	Additional control loop 6	20
6	Additional Axis 7	01	370292-01	Additional control loop 7	20
7	Additional Axis 8	03	370293-01	Additional control loop 8	20
8	Teach-In	01	632226-01	Cycle programming <ul style="list-style-type: none"> • Contour description with ICP • Cycle programming • Technology database with nine workpiece-material / tool-material combinations 	
9	smart.Turn	01	632227-01	smart.Turn <ul style="list-style-type: none"> • Contour description with ICP • Programming with smart.Turn • Technology database with nine workpiece-material / tool-material combinations 	
10	Tools and Technology	01	632228-01	Tools and technology <ul style="list-style-type: none"> • Tool database expanded to 999 entries • Technology database expanded to 62 workpiece-material/tool-material combinations • Tool life monitoring with exchange tools 	
11	Thread Recutting	01	632229-01	Threads <ul style="list-style-type: none"> • Thread recutting • Handwheel superimposition during thread cutting 	
17	Touch Probe Functions	01	632230-01	Tool measurement and workpiece measurement <ul style="list-style-type: none"> • Determining tool-setting dimensions with a tool touch probe • Determining tool-setting dimensions with an optical gauge • Automatic workpiece measurement with a workpiece touch probe 	
18	HEIDENHAIN DNC	01	526451-01	Communication with external PC applications over COM component	80
24	Gantry Axes	01	634621-01	Gantry axes via master-slave torque control	58
42	DXF Import	01	632231-01	DXF import: importing of DXF contours	
46	Python OEM Process	01	579650-01	Python application on the control	75
49	Double-Speed Axes	01	632223-01	Short control-loop cycle times for direct drives	64
54	B-Axis Machining	01	825742-01	B axis: tilting the working plane, rotating the machining position of the tool	58
55	C-Axis Machining	01	633944-01	C-axis machining	60
63	TURN PLUS	01	825743-01	TURN PLUS: automatic generation of smart.Turn programs	

Option number	Option	Starting with NC-Software 688946-688947-	ID	Comment	page
70	Y-Axis Machining	01	661881-01	Y-axis machining	
77	4 Additional Axes	03	634613-01	4 additional control loops	20
78	8 Additional Axes	03	634614-01	8 additional control loops	20
94	Parallel Axes	01	679676-01	Support of parallel axes (U, V, W) Combined display of principal axes and secondary axes	
101–130	OEM option	01	579651-01 to 579651-30	Options of the machine manufacturer	
131	Spindle Synchronism	01	806270-01	Synchronization (of two or more spindles)	61
132	Counter Spindle	01	806275-01	Counter spindle (spindle synchronization, rear-face machining)	60
133	Remote Desktop Manager	04	894423-01	Display and operation of external computer units (e.g., a Windows PC)	80
135	Synchronizing Functions	03	1085731-01	Expanded synchronization of axes and spindles	58
143	Load Adapt. Control	01	800545-01	LAC: load-dependent adaptation of control parameters	69
151	Load Monitoring	03	1111843-01	Monitoring of the tool load	68
153	Multichannel	05	1217032-01	Multi-channel capability: max. three channels for asynchronous multi-slide machining	59
155	Component Monitoring	07	1226833-01	Monitoring for component overloading and wear	68
160	Integrated FS: Basic	07	1249928-01	Enables functional safety and four safe control loops	53
161	Integrated FS: Full	07	1249929-01	Enables functional safety and the maximum number of safe control loops	53
162	Add. FS Ctrl. Loop 1	07	1249930-01	Additional control loop 1	53
163	Add. FS Ctrl. Loop 2	07	1249931-01	Additional control loop 2	53
164	Add. FS Ctrl. Loop 3	07	1249932-01	Additional control loop 3	53
165	Add. FS Ctrl. Loop 4	07	1249933-01	Additional control loop 4	53
166	Add. FS Ctrl. Loop 5	07	1249934-01	Additional control loop 5	53
169	Add. FS Full	08	1319091-01	Enabling of all FS axis options or control loops. Options 160 and 162 to 166 must already be set.	53

HSCI control components

Main computer

- Main computer**
- The MC main computers feature the following:
- Intel high-performance processor
 - Dual RAM
 - Gbit HSCI interface to the controller unit and to other control components
 - HDL2 interface to the BF monitor (with electrical cabinet versions)
 - Four USB 3.0 ports (e.g., for the TE 361 T (FS) operating panel)

To be ordered separately and installed in the main computer by the OEM:

- **CFR** memory card with the NC software
- The **System Identification Key** (SIK) component for enabling control loops and software options.

The following HSCI components are required for operation of the CNC PILOT 640:

- MC main computer
- Controller unit
- **PLB 62xx** or **PLB 62xx FS** PLC I/O unit (system PL; integrated into UxC)
- TE 361 T or TE 361 T FS or TE 725 T or TE 725 T FS keyboard with integrated machine operating panel

Interfaces

The MC is equipped with USB 3.0 and Ethernet ports. Connection to PROFIBUS DP or PROFINET IO is optionally possible via the individual additional modules or a combined PROFIBUS DP / PROFINET IO module.

Export version

Because the entire NC software is on the storage medium, no export version is required for the main computer itself. Only the easily replaceable storage medium and SIK component are available as export versions.

Gen 3 labels

The different Gen 3 labels identify how control components can be deployed.

The label indicates that a component is ready for operation in a Gen 3 (Gbit HSCI) drive system. Whether a component is suitable for functional safety (integrated FS, external FS, enabling of FS) must be considered separately.

Gen 3 ready

Gen 3 ready: These components can be used in systems with Gen 3 drives (UVR 3xx, UM 3xx, CC 3xx) and also in systems with a 1xx inverter system (UVR 1xx, UE 2xx, UR 2xx, CC 61xx).

Gen 3 exclusive

Gen 3 exclusive: These components can be used only in systems with Gen 3 drives (UVR 3xx, UM 3xx, CC 3xx).

Versions

Various versions of the MC main computer are available:

- Installation into the **operating panel**:
The MC 8420T (15.6-inch) or MC 366 (24-inch), along with the BF monitor, form a unit that is installed directly into the operating panel. With the exception of the power supply line, only one HSCI connecting cable to the electrical cabinet is needed
- Installation into the **electrical cabinet**:
The MC 306 is installed in the electrical cabinet. The operating panel requires HSCI, USB, and HDL2 cables as control lines



MC 306

The MC 8420T main computer is supported with NC software 68894x-05 or later. The MC 306 and MC 366 main computers are supported starting with NC software 68894x-08. Earlier software versions do not run on these MC main computers.



MC 8420T with main computer installed on the back

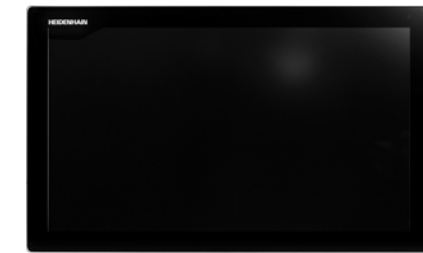

MC 366 with main computer installed on the back

Gen 3 ready

	Installation type	Storage medium	Processor	RAM	Power consumption ^{*)}	Mass	ID
MC 306	Electrical cabinet	CFR (30 GB)	Intel high-performance CPU	8 GB	≈ 65 W	≈ 4.2 kg	1180045-xx
MC 8420T¹⁾	Operating panel (15.6-inch)	CFR (30 GB)	Intel Celeron 1047 1.4 GHz, dual-core	4 GB	≈ 43 W	≈ 6.7 kg	1213689-xx
MC 366¹⁾	Operating panel (24-inch)	CFR (30 GB)	Intel Core i7-3, 1.7 GHz, dual-core (var. -01) / Intel high-performance CPU (var. -02)	8 GB	≈ 75 W	≈ 11.4 kg / ≈ 9.9 kg	1246689-01 / 1246689-02

^{*)} Test conditions: Windows 7 (64-bit) operating system, 100% processor load, interfaces not loaded, no fieldbus module

¹⁾ Fulfills IP54 when installed

Software options

Software options allow the performance of the CNC PILOT 640 to be adapted to one's actual needs at a later time. The software options are described on page 14. They are enabled by entering keywords based on the SIK number, and are saved in the SIK component. Please provide the SIK number when ordering new options.

Storage medium

The storage medium is a CFR (= CompactFlash Removable) compact flash memory card. It contains the NC software and is used to store NC and PLC programs. The storage medium is removable and must be ordered separately from the main computer.

This CFR uses the fast SATA protocol (CFast). This CFR is compatible with the MCs described in the **Main computers** section.

CFR CompactFlash, 30 GB	
Free PLC memory space	≈ 4 GiB
Free NC memory space	≈ 7.7 GiB
Export license required (NC SW 688946-18)	ID 1075088-18
Export license not required (NC-SW 688947-18)	ID 1075088-68



CFR CompactFlash

SIK component

The SIK component contains the **NC software license** for enabling control loops and software options. It provides the main computer with an unambiguous ID code—the SIK number. The SIK component is ordered and shipped separately. It must be inserted into a slot provided for it in the MC main computer.

The SIK component with the NC software license exists in different versions based on the enabled control loops and software options. Additional control loops can be enabled later by entering a keyword. HEIDENHAIN provides the keyword, which is based on the SIK number.

When ordering, please provide the SIK number of your control. When the keywords are entered in the control, they are saved in the SIK component, thereby enabling and activating the software options. Should servicing become necessary, the SIK component must be inserted into the replacement control in order to enable all of the required software options.

Master keyword (general key)

For putting the CNC PILOT 640 into service, there is a master keyword that enables all software options once for 90 days. After this period, the software options can be activated only with the correct keywords. The general key is activated via a soft key.

TNCkeygen (accessory)

TNCkeygen is a collection of PC software tools for generating enabling keys for HEIDENHAIN controls for a limited period of time.

With the **OEM Key Generator**, you can generate enabling keys for software options by entering the SIK number, the software option to be enabled, the enabling period, and an OEM-specific password. This activation is limited to a period of 10 to 90 days. Each software option can be enabled only once; this is performed independently of the master keyword.

The **OEM daily key generator** generates an enabling key for the protected OEM area, thus granting the user access on the day it is generated.



SIK component

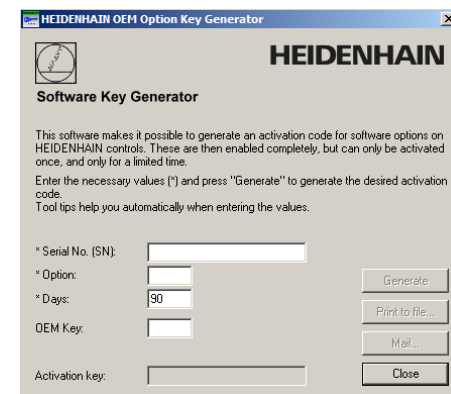

NC software license and enabling of control loops based on the CC

Three control loops are always enabled in the basic version. The controller unit must be designed for the corresponding number of activated control loops. Maximum possible: UEC 3x4: 4 control loops; UEC 3x5: 5 control loops; CC 302: 2 control loops; CC 308: 8 control loops; CC 310: 10 control loops. You can find the usual SIK combinations in the following table. Other versions are available upon request.

Control loops	Included options	SIK
3	• smart.Turn (option 9)	ID 686002-01 ID 686002-51*)
	• Teach-In (option 8) • smart.Turn (option 9) • Thread Recutting (option 11) • C-Axis Machining (option 55)	ID 686002-10 ID 686002-60*)
4	• smart.Turn (option 9) • C-Axis Machining (option 55)	ID 686002-03 ID 686002-53*)
4	• smart.Turn (option 9) • HEIDENHAIN DNC (option 18) • Python OEM Process (option 46) • C-Axis Machining (option 55)	ID 686002-61*)
5	• smart.Turn (option 9) • C-Axis Machining (option 55)	ID 686002-04 ID 686002-54*)
5	• smart.Turn (option 9) • Python OEM Process (option 46) • C-Axis Machining (option 55)	ID 686002-58*)
5	• smart.Turn (option 9) • C-Axis Machining (option 55) • Y-Axis Machining (option 70)	ID 686002-62*)
6	• smart.Turn (option 9) • C-Axis Machining (option 55) • Y-Axis Machining (option 70)	ID 686002-05 ID 686002-55*)
6	• smart.Turn (option 9) • Python OEM Process (option 46) • C-Axis Machining (option 55) • Y-Axis Machining (option 70)	ID 686002-59*)
6	• smart.Turn (option 9) • C-Axis Machining (option 55) • Counter Spindle (option 132)	ID 686002-63*)
7	• smart.Turn (option 9) • C-Axis Machining (option 55) • Y-Axis Machining (option 70) • Counter Spindle (option 132)	ID 686002-64*)
11	• smart.Turn (option 9) • B-Axis Machining (option 54) • C-Axis Machining (option 55) • Y-Axis Machining (option 70) • Integrated FS: Full (option 161)	1373591-01

*) Export version

Enabling further control loops

Further control loops can be enabled either as groups or individually. The combination of control-loop groups and individual control loops makes it possible to enable any number of control loops. Up to 24 control loops are possible.

Control-loop groups	Software option	
4 Additional Control Loops	77	ID 634613-01
8 Additional Control Loops	78	ID 634614-01

Individual control loops	Software option	
1st additional control loop	0	ID 354540-01
2nd additional control loop	1	ID 353904-01
3rd additional control loop	2	ID 353905-01
4th additional control loop	3	ID 367867-01
5th additional control loop	4	ID 367868-01
6th additional control loop	5	ID 370291-01
7th additional control loop	6	ID 370292-01
8th additional control loop	7	ID 370293-01

Matching keyboard for the 15.6-inch monitor

**TE 725T,
TE 725T FS**

Gen3 ready

- Suitable for MC 8420T (15.6")
- Numeric keypad
- ASCII keyboard
- Spindle-speed and feed-rate override potentiometers
- Two holes for additional keys or keylock switches
- USB interface to the MC main computer
- USB port with cover cap

Integrated machine operating panel with:

- Supply voltage: DC 24 V / \approx 4 W
- 36 exchangeable snap-on keys with status LEDs, freely definable via PLC
- Operating elements: keys preassigned by the PLC basic program: Control voltage on¹⁾; NC start¹⁾; NC stop¹⁾; emergency stop; axis direction keys; rapid traverse key; spindle start; spindle stop; jog spindle; spindle change key; feed rate stop
- Connection for HR handwheel
- HSCI interface
- TE 725T: 8 free PLC inputs and 8 free PLC outputs
- TE 725T FS: 4 free FS inputs and 8 free PLC outputs; additional dual-channel FS inputs for emergency stop and permissive buttons of the HR handwheel

¹⁾ Keys illuminated, addressable via PLC

TE 725T
TE 725T FS

Mass \approx 3.1 kg

ID 1264436-xx
ID 1211940-xx



TE 725T, TE 725T FS

24-inch screen and keyboard

BF 360 monitor

Gen 3 exclusive

- Supply voltage: DC 24 V/≈ 35 W
- **24-inch**; 1920 x 1024 pixels
- HDL2 interface to the MC in the electrical cabinet
- Integrated USB hub with four USB ports on the rear
- Display for multi-touch operation
- Fulfills IP54 when installed

BF 360 ID 1275079-xx
Mass ≈ 8.6 kg



BF 360

TE 361 T keyboard with integrated machine operating panel

Gen 3 ready

- General data:
- Fits the BF 360 or MC 366 (24-inch design)
 - All keycaps are exchangeable
 - USB interface to the MC main computer
 - Trackball
 - USB port with cover cap

Control keyboard (long stroke):

- Alphabetic keyboard block
- NC operating block
- Navigation block

Specifications:

- Supply voltage: DC 24 V/≈ 4 W
- Fulfills IP54 when installed (all keycaps must be in place)
- Integrated machine operating panel with 30 exchangeable, freely assignable key with status LED, freely definable via PLC (assignment in accordance with PLC basic program spindle stop, 16 further function keys)
- Other operating elements: NC start key¹⁾, NC stop key¹⁾, control voltage on/off key¹⁾, emergency stop button
- Override potentiometers for feed rate, rapid traverse, and spindle speed (all override potentiometers are fitted with an adapter so that they can be mounted in any 22.3 mm opening)
- 4 openings for operating elements with a mounting diameter of 22.3 mm
- Interface for HR handwheel
- HSCI interface, (Gbit HSCI)
- TE 361 T: 8 free PLC inputs and 8 free PLC outputs
TE 361 T FS: 4 free FS inputs and 8 free PLC outputs; additional dual-channel FS inputs for emergency stop and handwheel permissive buttons.

¹⁾ Illuminated keys, addressable via PLC

TE 361 T ID 1353434-xx
TE 361 T FS ID 1353431-xx
Mass ≈ 3.7 kg



TE 361 T

Extraction tool

For replacing keycaps on the TE 361 T ID 1394129-xx

Optional mounting set for the TE 361 T

For fastening the TE 361 T with mounting braces (set of 6 pieces). Up to 4 mounting braces can be fastened to a TE 361 T. ID 1278826-xx

PL 6000 PLC input/output systems with HSCI

PL 6000

The PLC inputs and outputs are available via external modular PL 6000 PLC input/output systems. They consist of a basic module and one or more input/output modules. A total maximum of 1000 inputs/outputs is supported. The PL 6000 units are connected to the MC main computer via the HSCI interface. The PL 6000 units are configured with the IOconfig PC software.



PLB 62xx

Basic modules

Basic modules with an **HSCI interface** exist for 4, 6, 8, and 10 modules. Fastening is performed on standard NS 35 rails (DIN 46227 or EN 50022).

Supply voltage DC 24 V
Power consumption¹⁾ ≈ 48 W at DC 24 V NC
≈ 21 W at DC 24 V PLC
Mass ≈ 0.65 kg to 1 kg (depending on the version)

¹⁾ PLB 6xxx completely filled, incl. TS, TT

System PL with EnDat support

- Required once for each control system (except with UxC)
- Connections for TS and TT touch probes
- TS and TT touch probes with EnDat interface are supported
- *Without FS*: 12 free inputs, 7 free outputs
With FS: 6 free FS inputs, 2 free FS outputs
- Functional safety (FS) is enabled via SIK options 160 to 166. Subsequent enabling of all FS control loops is via SIK option 169.
- Slots are equipped with cover strips

Gen 3 ready

PLB 6204 For 4 I/O modules ID 1129809-xx
PLB 6206 For 6 I/O modules ID 1129812-xx
PLB 6208 For 8 I/O modules ID 1129813-xx
PLB 6210 For 10 I/O modules ID 1278136-xx

Gen 3 exclusive

PLB 6204 FS For 4 I/O modules ID 1223032-xx
PLB 6206 FS For 6 I/O modules ID 1223033-xx
PLB 6208 FS For 8 I/O modules ID 1223034-xx
PLB 6210 FS For 10 I/O modules ID 1290089-xx

Note about the "Gen 3 ready" label:

The label expresses the fact that a component is ready for operation in a Gen 3 (Gbit HSCI) drive system. Whether a component is suitable for functional safety (integrated FS, external FS, enabling of FS) must be considered separately.

Expansion PL

Gen3 ready

For connection to the system PL to increase the number of PLC inputs/outputs

PLB 6104	For 4 I/O modules	ID 1129799-xx
PLB 6106	For 6 I/O modules	ID 1129803-xx
PLB 6108	For 8 I/O modules	ID 1129804-xx
PLB 6104 FS	For 4 I/O modules	ID 1129796-xx
PLB 6106 FS	For 6 I/O modules	ID 1129806-xx
PLB 6108 FS	For 8 I/O modules	ID 1129807-xx

Up to seven PLB 6xxx units can be connected to the control.

I/O modules

Gen3 ready

There are I/O modules with digital and analog inputs and outputs.

PLD-H 16-08-00	I/O module with 16 digital inputs and 8 digital outputs	ID 594243-xx
PLD-H 08-16-00	I/O module with 8 digital inputs and 16 digital outputs	ID 650891-xx
PLD-H 08-04-00 FS	I/O module with 8 digital FS inputs and 4 digital FS outputs	ID 598905-xx
PLD-H 04-08-00 FS	I/O module with 4 digital FS inputs and 8 digital FS outputs	ID 727219-xx
PLD-H 04-04-00 HSLs FS	I/O module with 4 digital FS inputs and 4 high-side/low-side FS outputs	ID 746706-xx

Total current Outputs 0 to 7: ≤ 2 A per output (≤ 8 A simultaneously)
 Power output Max. 200 W
 Mass ≈ 0.2 kg

PLA-H 08-04-04	Analog module for PL 6xxx with <ul style="list-style-type: none"> • 8 analog inputs, ±10 V • 4 analog outputs, ±10 V • 4 analog inputs for PT 100 thermistors 	ID 675572-xx
Mass	≈ 0.2 kg	

I/O module for axis release

Gen3 exclusive

Axis-release module for external safety. In combination with the PLB 620x without FS.

PAE-H 08-00-01	I/O module for enabling 8 axis groups	ID 1203881-xx
-----------------------	---------------------------------------	---------------

IOconfig (accessory)

PC software for configuring HSCI and PROFIBUS components

Accessories**HSCI adapter for OEM machine operating panel****PLB 600x**

Gen3 ready

The PLB 600x HSCI adapter is required in order to connect an OEM-specific machine operating panel to the CNC PILOT 640.

- HSCI interface
- Connection for HR handwheel
- Inputs and outputs for keys and key illumination
 - PLB 6001:* Terminals for 72 PLC inputs / 40 PLC outputs
 - PLB 6001 FS:* Terminals for 36 FS inputs / 40 PLC outputs
 - PLB 6002 FS:* Terminals for 4 FS inputs, 64 PLC inputs, and 40 PLC outputs
- Screw fastening or top-hat-rail mounting
- Configuration of the PLC inputs/outputs with the IOconfig computer software

PLB 6001	ID 668792-xx
PLB 6001 FS	ID 722083-xx
PLB 6002 FS	ID 1137000-xx
Mass	≈ 1.0 kg

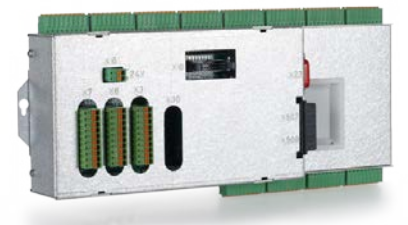

PLB 6001

Additional modules

Gen3 ready

Module for analog axes

Digital drive designs sometimes also require analog axes or spindles. The additional module CMA-H 04-04-00 (Controller Module Analog HSCI) makes it possible to integrate analog drive systems into an HSCI system.

The CMA-H is integrated into the HSCI control system via a slot on the underside of the CC or UEC. Every controller unit has slots for two boards. The CMA-H does not increase the total number of available axes: every analog axis used reduces the number of available digital control loops by one. Analog control loops also need to be enabled on the SIK. The analog control-loop outputs can be accessed only via the NC, not via the PLC.

Additional module for analog axes/spindles:

- Expansion board for the CC or UEC controller units
- 4 analog outputs, ± 10 V for axes/spindle
- Spring-type plug-in terminals

CMA-H 04-04-00

ID 688721-xx



CMA-H 04-04-00

Fieldbus systems

An expansion board can be used to provide the CNC PILOT 640 with a PROFIBUS or PROFINET interface at any time. The modules are integrated into the control system through a slot on the MC. This makes the connection to an appropriate fieldbus system as a master possible. With version 3.0 or later, the interface is configured with IOconfig.

PROFIBUS DP module

- Expansion board for the MC main computer
- Connection for 9-pin D-sub connector (female) to X121

MC 366 and MC 8420T ID 828539-xx
MC 306 and MC 366 as of variant -02 ID 1279074-xx



PROFIBUS DP module

PROFINET IO module

- Expansion board for the MC main computer
- RJ45 connection at X621 and X622

MC 366 and MC 8420T ID 828541-xx
MC 306 and MC 366 as of variant -02 ID 1279077-xx



PROFINET IO module

Combined PROFIBUS DP/PROFINET IO module

- Expansion board for the MC main computer
- RJ45 connection at X621 (PROFINET IO) and M12 connector at X121 (PROFIBUS DP)
- Additionally connectable terminating resistor for PROFIBUS DP with front LED

MC 366 and MC 8420T ID 1160940-xx
MC 306 and MC 366 as of variant -02 ID 1233765-xx



Combined module

Electronic handwheels

Gen3 ready

Overview

The standard CNC PILOT 640 supports the use of electronic handwheels:

- **HR 550 FS** wireless handwheel or
- **HR 510, HR 510 FS** or **HR 520, HR 520 FS** portable handwheel or
- **HR 130** panel-mounted handwheel

Several handwheels can be operated on a single CNC PILOT 640:

- One handwheel via the handwheel input of the main computer (not on main computers in the electrical cabinet)
- One handwheel each on HSCI machine operating panels or PLB 6001 or PLB 600x FS HSCI adapters (for the maximum number possible, see Page 52)

The mixed operation of handwheels with and without display is not possible. Handwheels with functional safety (FS) are cross-circuit-proof due to special permissive-button logic.

HR 510

Portable electronic handwheel with:

- Keys for actual-position capture and the selection of five axes
- Keys for traverse direction and three preset feed rates
- Three keys for machine functions (see below)
- Emergency stop button and two permissive buttons (24 V)
- Magnetic holding pads

All keys are designed as snap-on keys and can be replaced with other symbols (see *Overview for the HR 510 in Snap-on keys for the HR*).



HR 510

	Keys	Without detent	With detent
HR 510	NC start/stop, spindle start (for basic PLC program)	ID 1119971-xx	ID 1120313-xx
	FCT A, FCT B, FCT C	ID 1099897-xx	–
	Spindle right/left/stop	ID 1184691-xx	–
HR 510 FS	NC start/stop, spindle start (for basic PLC program)	ID 1120311-xx	ID 1161281-xx
	FCT A, FCT B, FCT C	–	ID 1120314-xx
	Spindle start, FCT B, NC start	–	ID 1119974-xx

Mass \approx 0.5 kg

HR 520

- Portable electronic handwheel with
- Display for operating mode, actual position value, programmed feed rate, spindle speed, and error messages
 - Override potentiometers for feed rate and spindle speed
 - Selection of axes via keys or soft keys
 - Actual position capture
 - NC start/stop
 - Spindle on/off
 - Keys for continuous traverse of the axes
 - Soft keys for machine functions of the machine manufacturer
 - Emergency stop button

	Without detent	With detent
HR 520	ID 670302-xx	ID 670303-xx
HR 520 FS	ID 670304-xx	ID 670305-xx

Mass ≈ 0.6 kg



HR 520

Holder for HR 520

For attaching to a machine ID 591065-xx

HR 550 FS

Electronic handwheel with wireless transmission. Display, operating elements, and functions are like those of the HR 520

In addition:

- Functional safety (FS)
- Radio transmission range of up to 20 m (depending on environment)

HR 550 FS	Without detent	ID 1200495-xx
	With detent	ID 1183021-xx

Replacement battery	For HR 550 FS	ID 623166-xx
----------------------------	---------------	--------------



HR 550 FS with HRA 551 FS

HRA 551 FS

- Handwheel holder for HR 550 FS
- For docking the HR 550 FS on the machine
 - Integrated battery charger for HR 550 FS
 - Connections to the control and the machine
 - Integrated transceiver
 - HR 550 FS magnetically held to front of HRA 551 FS

HRA 551 FS	ID 1119052-xx
Mass	≈ 0.7 kg

For more information, see the *HR 550 FS* Product Information document.

Connecting cables

	HR 510	HR 510 FS	HR 520	HR 520 FS	HR 550 FS with HRA 551 FS	
Connecting cable (spiral cable) to HR (3 m)	–	–	✓	✓	–	ID 312879-01
	✓	✓	–	–	–	ID1117852-03
Connecting cable with metal armor	–	–	✓	✓	–	ID 296687-xx
	✓	✓	–	–	–	ID 1117855-xx
Connecting cable without metal armor	–	–	✓	✓	✓ (max. 2 m)	ID 296467-xx
	✓	✓	–	–	–	ID 1117853-xx
HR adapter cable to MC, straight connector	✓	✓	✓	✓	✓ ¹⁾	ID 1161072-xx
HR adapter cable to MC, angled connector (1 m)	✓	✓	✓	✓	✓ ¹⁾	ID 1218563-01
Extension cable to adapter cable	✓	✓	✓	✓	✓ ¹⁾	ID 281429-xx
Adapter cable for HRA to MC	–	–	–	–	✓ ²⁾	ID 749368-xx
Extension cable to adapter cable	–	–	–	–	✓ ²⁾	ID 749369-xx
Adapter connector for handwheels without functional safety	✓	–	✓	–	–	ID 271958-03
Adapter connector for handwheels with functional safety	–	✓	–	✓	✓	ID 271958-05

¹⁾ For maximum cable lengths up to 20 m between the MB and HRA 551 FS

²⁾ For maximum cable lengths up to 50 m between the MB and HRA 551 FS

See also *Cable overview* Page 50.

HR 130

Panel-mounted handwheel with ergonomic control knob. It is attached to the TE 7x5T either directly or via an extension cable.

HR 130	Without detent	ID 540940-03
	With detent	ID 540940-01
Mass	≈ 0.3 kg	



HR 130

Industrial PCs/ITC

Gen3 ready

Additional operating station with touchscreen

The additional ITC operating stations (Industrial Thin Client) from HEIDENHAIN are convenient solutions for the additional, decentralized operation of the machine or of machine units such as tool-changing stations. The remote operation strategy, which is tailored to the CNC PILOT 640, makes it very easy to connect the ITC over a standard Ethernet connection with a cable length of up to 100 m. All ITCs fulfill IP54 when installed.

Connecting an ITC is very easy: as soon as the CNC PILOT 640 identifies an ITC, it provides it with a current operating system. After booting of the ITC, the complete content of the control's screen is mirrored 1:1 on the ITC's screen. As a result of this plug&play principle, no configuration by the machine manufacturer is necessary. With the standard configuration of the Ethernet interface at X116, the CNC PILOT 640 integrates the ITC into the system fully self-sufficiently.

The **ITC 362** or **ITC 860** is an additional operating station for control systems with a main screen.

The **ITC 362** or **ITC 860** and the separately orderable keyboard unit together form a complete, second operating station.

Along with the touchscreen, the **ITC 855** also has an ASCII keyboard and the most important function keys of the CNC PILOT 640.

ITC 362	ID number	ID 1346871-xx
	Mass	≈ 8.6 kg
	Installation type	Operating panel
	Monitor	ITC 755 (full HD, 1920 x 1080 pixels)
	Processor	Intel Atom processor
	RAM	2 GB
	Power consumption	≈ 50 W

ITC 860	ID number	ID 1174935-xx
	Mass	≈ 8.2 kg
	Installation type	Operating panel
	Display	19-inch touchscreen (1280 x 1024 pixels)
	Processor	Intel Atom E3845 1.9 GHz
	RAM	2 GB
	Power consumption	≈ 50 W



ITC 362



ITC 860

IPC 306 for Windows

With the IPC 306 industrial PC, you can start and remotely operate Windows-based applications via the user interface of the CNC PILOT 640. The user interface is displayed on the control screen. Option 133 is required for this.

Since Windows runs on the industrial PC, it does not influence the NC machining process. The IPC is connected to the NC main computer via Ethernet. No second screen is necessary, since the Windows applications are displayed on the screen of the CNC PILOT 640 via remote accesses.

Along with the industrial PC, a separately orderable hard disk is required for operation. Windows 8, 10 or 11 can be installed on the empty data carrier as the operating system.

IPC 306	ID number	ID 1179966-xx
	Installation type	Electrical cabinet
	Mass	≈ 4.2 kg
	RAM	8 GB
	Processor	Intel high performance processor
	Power consumption	65 W
SSDR solid-state memory	ID number	ID 1282884-51
	Memory space	≈ 240 GB

HDMI adapter cable for commissioning ID 1333118-01



ITC 855



IPC 306

Control of auxiliary axes

Gen3 ready

PNC 610

The PNC 610 auxiliary axis control is designed for controlling PLC axes independently of the CNC PILOT 640. The PNC 610 does not have an NC channel and thus cannot perform interpolating NC movements. With the IPC auxiliary computer, SIK, and CFR storage medium, the PNC 610 is a separate HSCI system, which can be expanded with HEIDENHAIN inverters. In the standard version the PNC 610 already includes six PLC axis releases as well as software option 46 (Python OEM Process). The PLC basic program contains a Python interface for pallet management that is adaptable by the machine manufacturer.

The system's design is identical to that of the CNC PILOT 640. All relevant HEIDENHAIN tools and a basic program can be used. The position information can be transmitted over PROFIBUS DP (optional), PROFINET IO (optional), or TCP/IP (integrated, system is not capable of real-time), regardless of the platform.

Auxiliary computer

The IPC auxiliary computer features the following:

- Intel mid-level processor
- RAM main memory
- HSCI interface to the CC controller unit or to the UxC and to other control components
- USB 3.0 ports

The following components must be ordered separately by the OEM and installed in the auxiliary computer:

- CFR memory card with the NC software
- System Identification Key component (SIK) for enabling software options

The following HSCI components are required for operating the PNC 610:

- IPC auxiliary computer
- Controller unit
- PLB 62xx PLC I/O unit (system PL; integrated into UxC)

Interfaces

USB 3.0 and Ethernet are available on the MC. The connection to PROFINET IO or PROFIBUS DP is possible via an additional module.

Design

IPC 6490	ID number	ID 1039541-xx
	Installation type	Electrical cabinet
	Mass	≈ 2.3 kg
	Power consumption	48 W
	RAM	2 GB
	Processor	Intel Celeron
IPC 8420	ID number	ID 1249510-xx
	Installation type	Operating panel (IP54 when installed)
	Mass	≈ 6.6 kg
	Power consumption	48 W
	Monitor	15.6-inch touchscreen (1366 x 768 pixels)
	RAM	2 GB
	Processor	Intel Celeron

Export version

Because the entire NC software is saved on the CFR CompactFlash storage medium, no export version is required for the main computer itself. The NC software of the PNC 610 needs no export license.



PNC 610 with IPC 8420

Software options

The performance of the PNC 610 can also be adapted to the actual requirements at a later time through software options. Software options are enabled and saved in the SIK component through the entry of keywords based on the SIK number. Please provide the SIK number when ordering new options.

Option number	Option	ID	Comment	Page
18	HEIDENHAIN DNC	526451-01	Communication with external PC applications over COM component	
24	Gantry Axes	634621-01	Gantry axes via master-slave torque control	58
135	Synchronizing Functions	1085731-01	Advanced synchronization of axes and spindles	
143	Load Adapt. Control	800545-01	LAC: load-dependent adaptation of control parameters	69
160	Integrated FS: Basic	1249928-01	Enables functional safety and four safe control loops	53
161	Integrated FS: Full	1249929-01	Enables functional safety and the maximum number of safe control loops	53
162	Add. FS Ctrl. Loop 1	1249930-01	Additional control loop 1	53
163	Add. FS Ctrl. Loop 2	1249931-01	Additional control loop 2	53
164	Add. FS Ctrl. Loop 3	1249932-01	Additional control loop 3	53
165	Add. FS Ctrl. Loop 4	1249933-01	Additional control loop 4	53
166	Add. FS Ctrl. Loop 5	1249934-01	Additional control loop 5	53
169	Add. FS Full	1319091-01	Enabling of all FS axis options or control loops. Options 160 and 162 to 166 must already be set.	53

Storage medium

The storage medium is a CFR (= CompactFlash Removable) compact flash memory card. It contains the NC software and must be ordered separately from the main computer. The NC software is based on the HEIDENHAIN HEROS 5 operating system.

CFR CompactFlash , 30 GB	ID 1102057-xx
No export license required	
NC software	817591-xx
Free PLC memory space	4 GiB
Free NC memory space	7.7 GiB

SIK component

The SIK component holds the NC software license for enabling software options. It provides the main computer with an unambiguous ID code—the SIK number. The SIK component is ordered and shipped separately. It must be inserted into a special slot in the IPC auxiliary computer. The SIK component of the PNC can enable six axes. The enabling of up to the maximum number of ten axes must be performed via the UMC compact inverter.

SIK component for PNC 610	ID 617763-53
----------------------------------	--------------

Snap-on keys for handwheels

Snap-on keys

The snap-on keys make it easy to replace the key symbols. In this way, the HR handwheel can be adapted to different requirements.

Overview for HR 520, HR 520 FS, and HR 550 FS

Axis keys Orange	ID 330816-42	ID 330816-24	ID 330816-43	ID 330816-37	
	ID 330816-26	ID 330816-36	ID 330816-38		
	ID 330816-23	ID 330816-25	ID 330816-45		
Gray	ID 330816-95	ID 330816-69	ID 330816-0W	ID 330816-0R	
	ID 330816-96	ID 330816-0G	ID 330816-0V	ID 330816-0D	
	ID 330816-97	ID 330816-0H	ID 330816-0N	ID 330816-0E	
	ID 330816-98	ID 330816-71	ID 330816-0M	ID 330816-65	
	ID 330816-99	ID 330816-72	ID 330816-67	ID 330816-66	
	ID 330816-0A	ID 330816-63	ID 330816-68	ID 330816-19	
	ID 330816-0B	ID 330816-64	ID 330816-21	ID 330816-16	
	ID 330816-0C	ID 330816-18	ID 330816-20	ID 330816-0L	
	ID 330816-70	ID 330816-17	ID 330816-0P	ID 330816-0K	
	Machine functions	ID 330816-0X	ID 330816-75	ID 330816-0T	ID 330816-86
Black ID 330816-1Y		ID 330816-76	ID 330816-81	ID 330816-87	
Black ID 330816-30		ID 330816-77	ID 330816-82	ID 330816-88	
Black ID 330816-31		ID 330816-78	ID 330816-83	ID 330816-94	
Black ID 330816-32		ID 330816-79	ID 330816-84	ID 330816-0U	
ID 330816-73		ID 330816-80	ID 330816-89	ID 330816-91	
ID 330816-74		ID 330816-0S	ID 330816-85	ID 330816-3L	
Spindle functions		Red ID 330816-08	ID 330816-40	Red ID 330816-47	ID 330816-48
		Green ID 330816-09	ID 330816-41	Green ID 330816-46	ID 385530-5X
Other keys		Black ID 330816-01	Red ID 330816-50	ID 330816-90	ID 330816-93
	Gray ID 330816-61	ID 330816-33	Black ID 330816-27	ID 330816-0Y	
	Green ID 330816-11	ID 330816-34	Black ID 330816-28	Black ID 330816-4M	
	Red ID 330816-12	ID 330816-13	Black ID 330816-29	ID 330816-3M	
	Green ID 330816-49	Green ID 330816-22	ID 330816-92	ID 330816-3N	

Overview for HR 510 and HR 510 FS

Axis keys Orange	ID 1092562-02	ID 1092562-05	ID 1092562-36	ID 1092562-08
	ID 1092562-03	ID 1092562-06	ID 1092562-09	
	ID 1092562-04	ID 1092562-07	ID 1092562-37	
Gray	ID 1092562-28	ID 1092562-31	ID 1092562-24	ID 1092562-27
	ID 1092562-29	ID 1092562-32	ID 1092562-25	
	ID 1092562-30	ID 1092562-33	ID 1092562-26	
Machine functions	Black ID 1092562-14	Black ID 1092562-15	Black ID 1092562-16	ID 1092562-42
	ID 1092562-43	ID 1092562-44		
Spindle functions	ID 1092562-18	ID 1092562-19	Green ID 1092562-22	Red ID 1092562-17
	Red ID 1092562-38	ID 1092562-41		
Other keys	Black ID 1092562-01	Green ID 1092562-23	ID 1092562-13	ID 1092562-35
	Green ID 1092562-20	ID 1092562-11	Black ID 1092562-10	Gray ID 1092562-39
	Red ID 1092562-21	ID 1092562-12	ID 1092562-34	Orange ID 1092562-40

Snap-on keys for the control

Snap-on keys

The snap-on keys make it easy to replace the key symbols, thus allowing the keyboard to be adapted to different requirements.











The snap-on keys with ID 679843-xx are suitable for the following machine operating panels:

- TE 725T (built-in machine operating panel)
- TE 725T FS (built-in machine operating panel)







































Special keys

Keycaps can also be made with special key symbols for special applications. If you need keys for special applications, please consult your contact person at HEIDENHAIN.













































Keys Orange

	ID 679843-31		ID 679843-54		ID 679843-C8		ID 679843-D4
	ID 679843-32		ID 679843-55		ID 679843-C9		
	ID 679843-53		ID 679843-88		ID 679843-D3		

Gray

	ID 679843-03		ID 679843-13		ID 679843-93		ID 679843-B9
	ID 679843-04		ID 679843-14		ID 679843-94		ID 679843-C1
	ID 679843-05		ID 679843-43		ID 679843-B1		ID 679843-C2
	ID 679843-06		ID 679843-44		ID 679843-B2		ID 679843-C3
	ID 679843-07		ID 679843-67		ID 679843-B3		ID 679843-C4
	ID 679843-08		ID 679843-68		ID 679843-B4		ID 679843-C5
	ID 679843-09		ID 679843-69		ID 679843-B5		ID 679843-D9
	ID 679843-10		ID 679843-70		ID 679843-B6		ID 679843-E1
	ID 679843-11		ID 679843-91		ID 679843-B7		
	ID 679843-12		ID 679843-92		ID 679843-B8		

Machine functions

	ID 679843-01		ID 679843-30		ID 679843-74		ID 679843-C6
	ID 679843-02		ID 679843-40		ID 679843-76		Black ID 679843-C7
	ID 679843-16		Green ID 679843-56		Black ID 679843-95		SPEC FCT ID 679843-D6
	ID 679843-22		Red ID 679843-57		Black ID 679843-96		ID 679843-E3
	ID 679843-23		+		Black ID 679843-A1		FCT RC ID 679843-E4
	ID 679843-24		-		ID 679843-A2		ID 679843-E6
	ID 679843-25				ID 679843-A3		ID 679843-E7
	ID 679843-26				ID 679843-A4		ID 679843-E8
	ID 679843-27		FCT		ID 679843-A5		
	ID 679843-28				ID 679843-A6		
	ID 679843-29				ID 679843-A9		

Keycaps for keyboard units and machine operating panels

Spindle functions

	ID 679843-18		ID 679843-47		Red ID 679843-52		ID 679843-99
	ID 679843-19		ID 679843-48		ID 679843-65		Green ID 679843-D8
	ID 679843-20		ID 679843-49		Green ID 679843-71		ID 679843-F2
	ID 679843-21		ID 679843-50		ID 679843-72		
	ID 679843-46		ID 679843-51		Red ID 679843-89		

Other keys

	ID 679843-15		ID 679843-39		ID 679843-97		Black ID 679843-E2
	ID 679843-17		ID 679843-41		ID 679843-98		ID 679843-E5
	Gray ID 679843-33		ID 679843-42		ID 679843-A7		ID 679843-F3
	Black ID 679843-34		Red ID 679843-45		ID 679843-A8		ID 679843-F4
	Orange ID 679843-35		ID 679843-58		Black ID 679843-D1		ID 679843-F5
	ID 679843-36		ID 679843-66		Black ID 679843-D2		ID 679843-F6
	ID 679843-37		ID 679843-75		ID 679843-D5		
	ID 679843-38		Green ID 679843-90		Red ID 679843-D7		

Keycaps

The keycaps make it easy to replace the key symbols, thus allowing the keyboard to be adapted to different requirements.

Overview of control keys







The keycaps with IDs 12869xx-xx and 1344337-xx are suitable for use on the following keyboard units and machine operating panels:

- TE 361 T
- TE 361 TFS







Keycaps for alphabetic keyboard

						% 5 icon"/>			
ID 1286909	-08	-09	-10	-11	-12	-13	-14	-15	-16
ID 1286909	-17	-18	-19	-20	-21	-22	-23	-24	-25
						{ icon"/>			
ID 1286909	-26	-27	-28	-29	-30	-31	-32	-33	-34
ID 1286909	-35	-36	-	-38	-39	-	-41	-42	-43
ID 1344337*)	-	-	-01*)	-	-	-02*)	-	-	-
*) With tactile mark									
ID 1286909	-44	-45	-46	-47	-48	-49	-50	-51	-52
ID 1286909	-53	-54	-55	-56	-57	-58	-59	-60	
ID 1286911	-02	-03	-04	-05					
ID 1286914	-03								
ID 1286915	-02	-03							
ID 1286917	-01								









Keycaps for operating aids









							
ID 1286909	-61	-62	-63	-64	-65	-66	

Keycaps for operating modes

								
ID 1286909	-67	-68	-69	-70	-71	-72	-73	-74









Keycaps for programming

									
ID 1286909	-75	-76	-77	-78	-79	-80	-81	-82	-83

									
ID 1286909	-84	-85	-86	-87	-88	-89	-90	-91	-93









									
ID 1286909	-92								









Keycaps for axis input and value input





									
ID 1286909	-94	-95	-96	-4K	-4Y	-4L	-5K	-98	-4Z

									
ID 1286909	-0B	-0C	-0D	-0E	-	-0G	-0H	-2L	-2M
ID 1344337*)	-	-	-	-	-03*)	-	-	-	-

*) With tactile mark

									
ID 1286909	-97	-0N	-3S	-4S	-4T	-3R	-3T	-3U	-3V

									
ID 1286909	-0K	-0L	-0M	-2N	-0P	-2P	-0R	-0S	-3N

									
ID 1286909	-3W	-3P	-99	-0A					

									
ID 1286914	-04								

Keycaps for navigation

		HOME	PG UP		GOTO		END	PG DN	
ID 1286909	-0T	-0U	-0V	-0W	-	-0Y	-0Z	-1A	
ID 1344337*)	-	-	-	-	-04*)	-	-	-	

*) With tactile mark

ID 1344337*)	-06	-07	

*) With tactile mark

Keycaps for machine functions

	IV+	Z+	Y+	V+	VI+	X+			Y-
ID 1286909	-1D	-1E	-1F	-1G	-1H	-1K	-1L	-4X	-1N

	IV-	VI-			FN 1				
ID 1286909	-1P	-1R	-1S	-1T	-1U	-1V	-1W	-1X	-1Y

	FN 2			FN 3					X-
ID 1286909	-1Z	-2A	-2B	-2C	-2D	-2E	-2H	-2K	-2R

		Z-	V-	+	-				
ID 1286909	-	-2T	-2U	-2Z	-3A	-3E	-3F	-3G	-3H
ID 1344337*)	-05*)	-	-	-	-	-	-	-	-

*) With tactile mark

						C+		C-	
ID 1286909	-3L	-3M	-3X	-3Y	-3Z	-4A	-4B	-4C	-4D

	W+	W-		A+	A-	B+	B-		
ID 1286909	-4E	-4F	Red	-4M	-4N	-4P	-4R	Red	Red

		U-	U+			FN 4	FN 5		
ID 1286909	Green	-07	-5A	-5B	-5C	-5D	-4V	-4W	-5E

ID 1286909	-5F	-5G	2Y	-3K	-4G	-2V	-2W	-2X	

Other keycaps

ID 1286909	-01	-02	Orange	Green	Red	-	-	-	-

Special keys

Keycaps can also be made with special key symbols for special applications. If you need keys for special applications, please consult your contact person at HEIDENHAIN.

Cable overview

Control system with CC or UEC (MC in electrical cabinet)

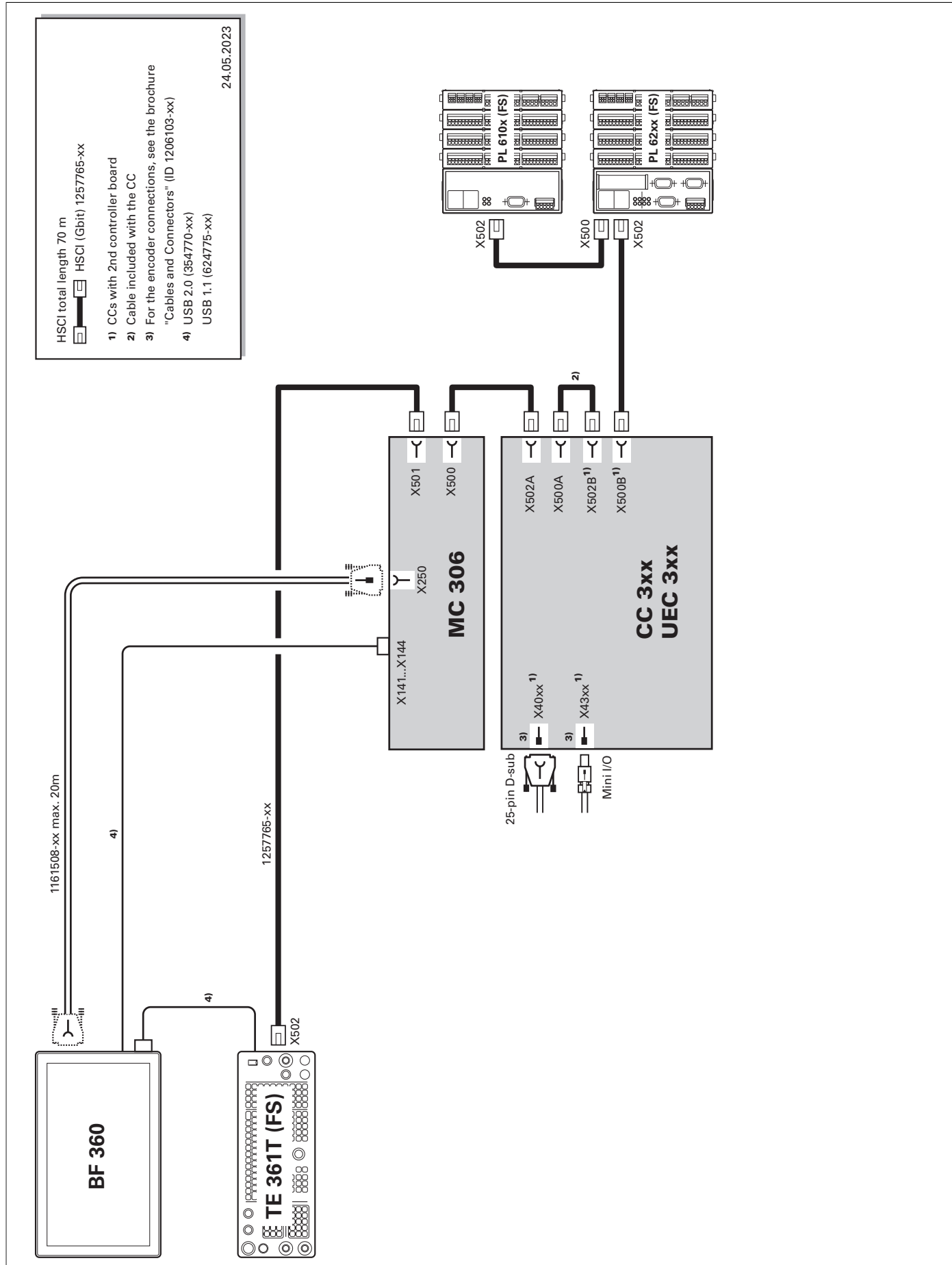

Control system with CC or UEC (MC in operating panel)

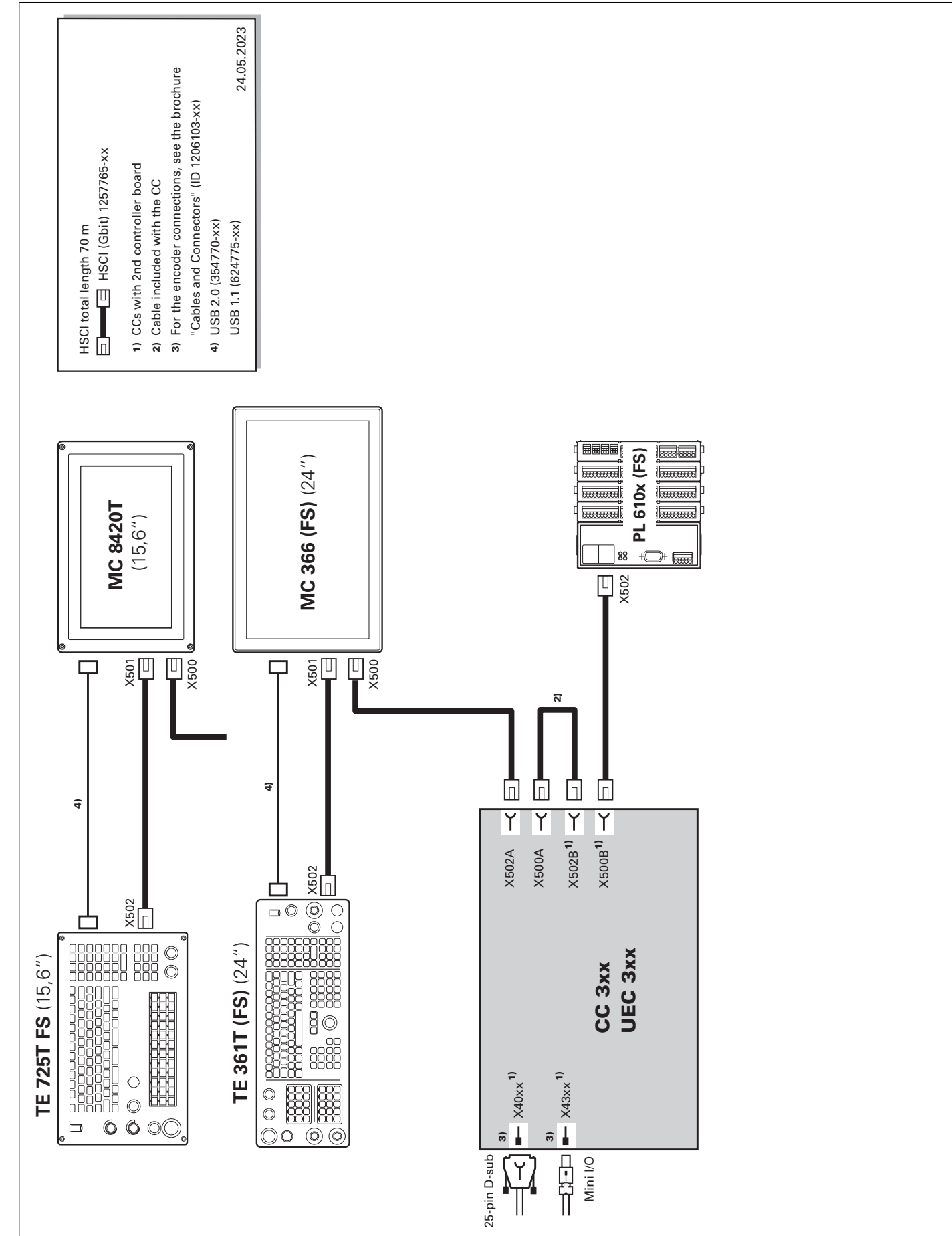

UEC 3xx (FS)

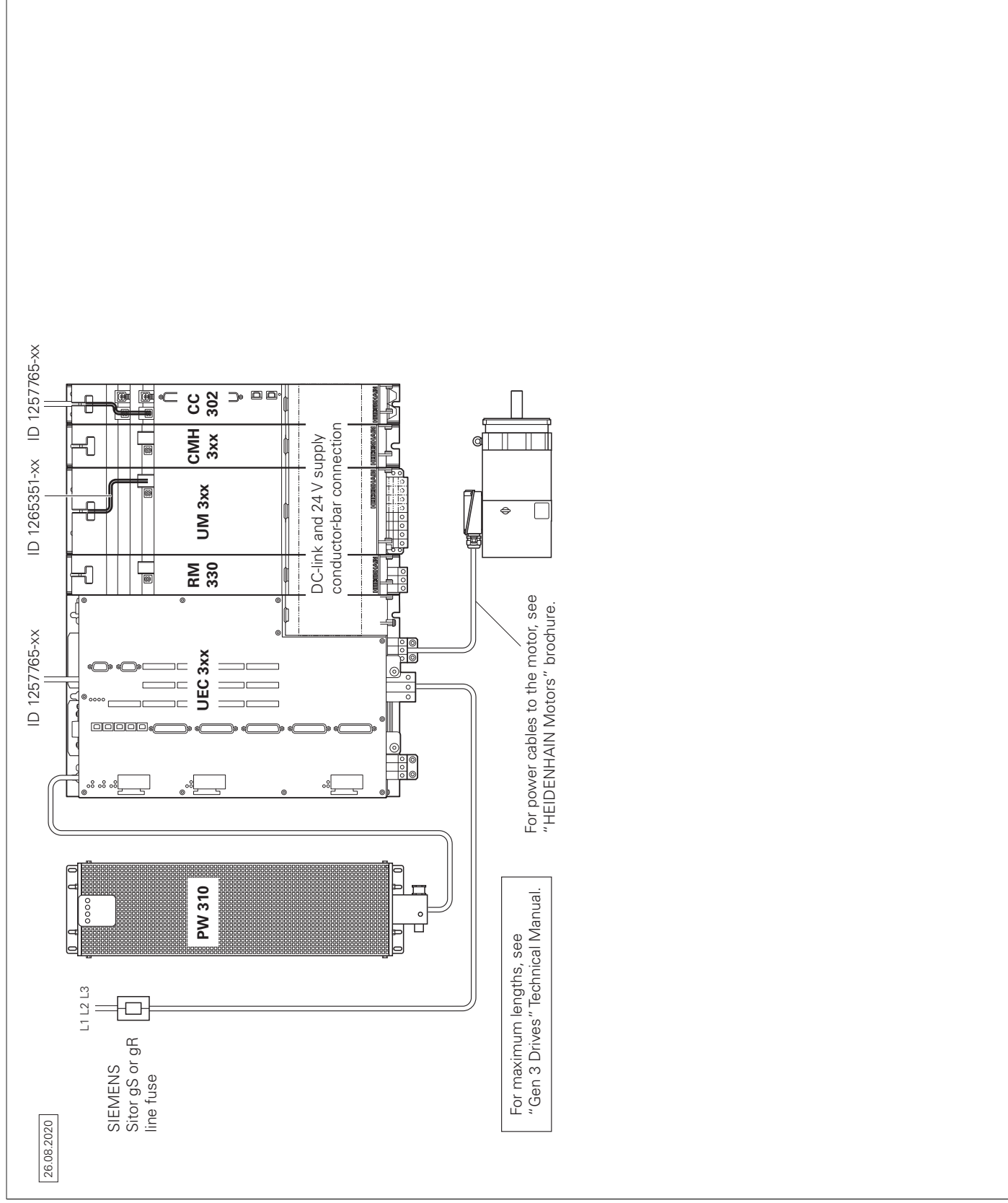

Encoders

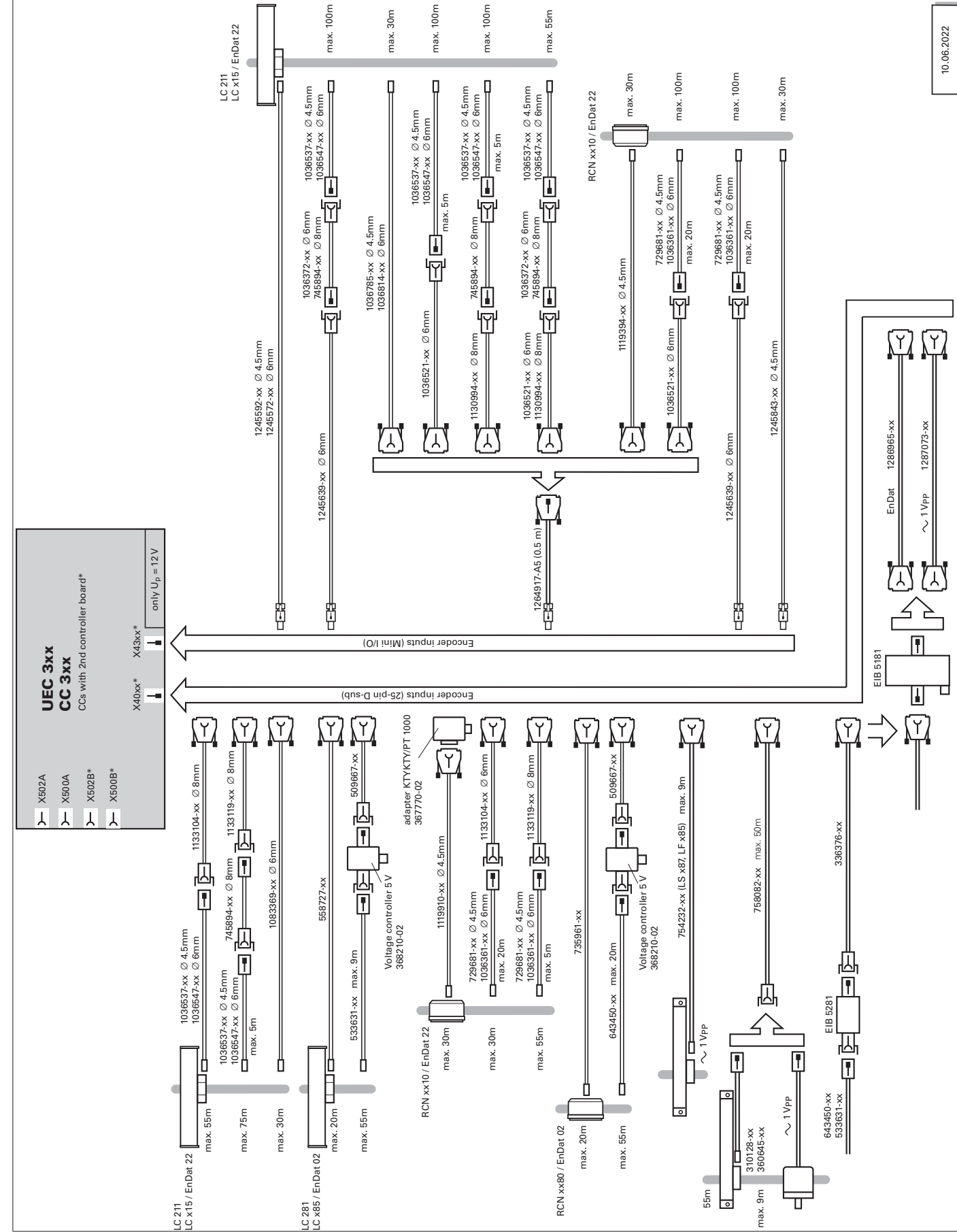

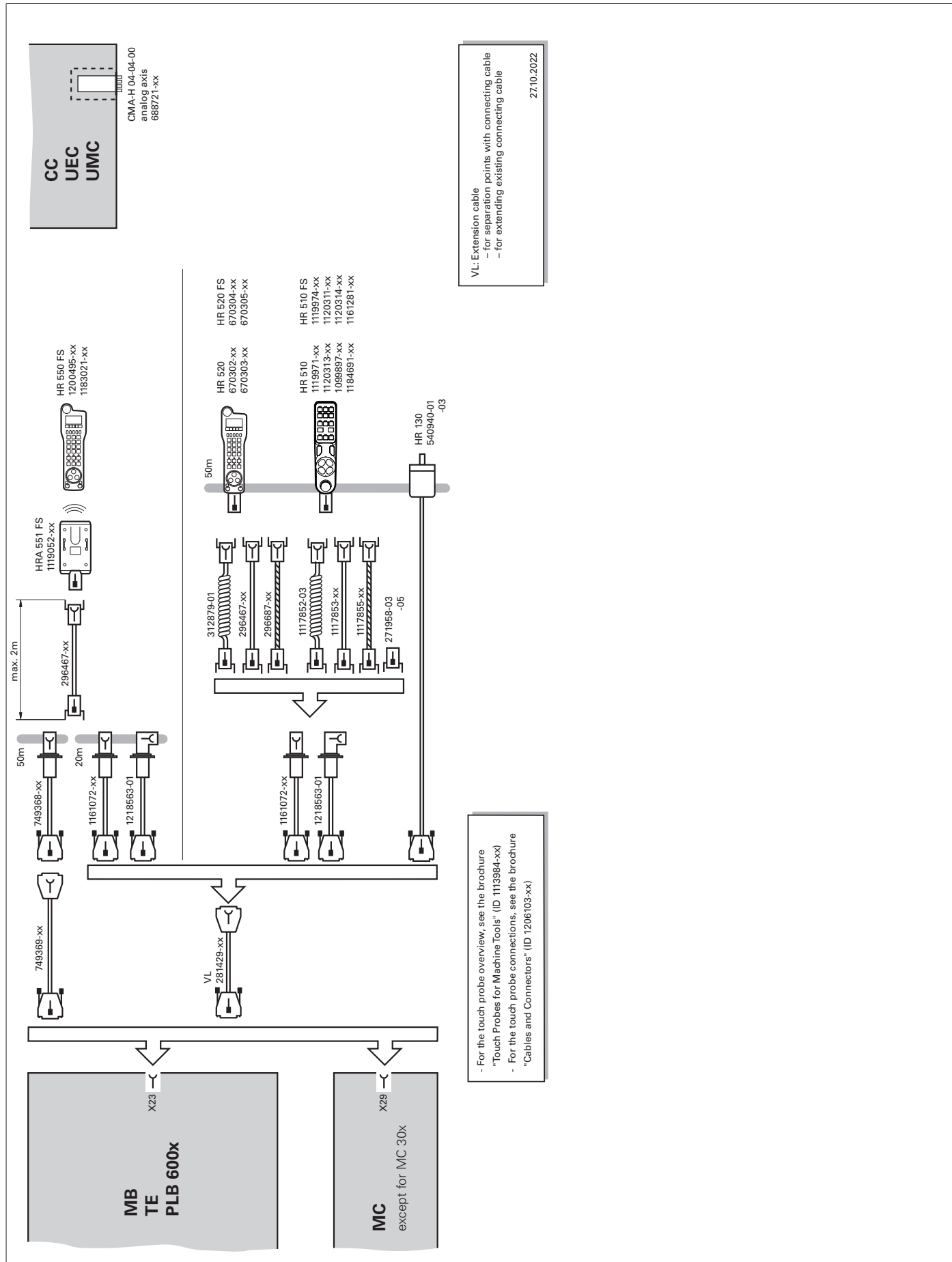

Technical description

Digital control design

Uniformly digital

In the uniformly digital control design from HEIDENHAIN, all of the components are connected with each other via purely digital interfaces. A high degree of availability for the entire system, from the main computer to the encoder, is thereby achieved, with the system being diagnosable and immune to noise. The outstanding characteristics of the uniformly digital design from HEIDENHAIN guarantee very high accuracy and surface finish quality, combined with high traversing speeds.

Connection of the components:

- Control components via **HSCI** (HEIDENHAIN Serial Controller Interface), the HEIDENHAIN real-time protocol for Gigabit Ethernet
- Encoders via the **EnDat 2.2** bi-directional interface from HEIDENHAIN
- Power modules via digital optical fiber cables

HSCI

HSCI, the HEIDENHAIN Serial Controller Interface, connects the main computer, controller(s), and other control components. The connection between two HSCI components is referred to as an HSCI segment. HSCI communication in Gen 3 control systems is based on Gigabit Ethernet hardware. All HSCI components and HSCI cables must therefore be Gigabit-capable. A special interface component developed by HEIDENHAIN makes short cycle times for data transfer possible.

Main advantages of the control design with HSCI:

- Hardware platform for a flexible and scalable control system (e.g., decentralized axis systems)
- High noise immunity due to digital communication between components
- Hardware basis for implementing functional safety
- Simple wiring (commissioning, configuration)
- Inverter connection via digital optical fiber cables
- Long line lengths in the overall system
- High number of possible control loops
- High number of PLC inputs/outputs
- Decentralized arrangement of the controller units

CC or UEC controller units, up to nine PL 6000 PLC I/O modules, and machine operating panels can be connected to the serial HSCI bus of the MC main computer. The HR handwheel is connected directly to the machine operating panel. The combination of monitor and main computer is especially advantageous if the computer is housed in the operating panel. Besides the power supply, all that is then required is an HSCI line to the controller unit in the electrical cabinet.

Maximum cable lengths for HSCI:

- For an HSCI segment: 70 m
- For up to 12 HSCI slaves: 290 m (total of all HSCI segments)
- For up to 13 HSCI slaves (maximum configuration): 180 m (total of all HSCI segments)

The order of the HSCI slaves can be freely chosen.

Control systems with integrated functional safety (FS)

The maximum permissible number of individual HSCI participants is listed below:

Gbit HSCI component		Maximum number in the control system ¹⁾
MC, IPC	HSCI master	1
CC, UEC (drive-control motherboards)	HSCI slave	6
UVR	HSCI slave	5
MB, PLB 600x	HSCI slave	2
PLB 6xxx (integrated in UEC 3xx (FS))	HSCI slave	7
PLB 6xxx FS (integrated in UEC 3xx FS)	HSCI slave	2
HR		5
PLD-H xx-xx-xx FS	In PLB 6xxx FS	10 ²⁾
PLD-H xx-xx-xx, PLA-H xx-xx-xx	In PLB 6xxx (FS)	25 ²⁾
PAE-H xx-xx-xx	In PLB 62xx	1 ³⁾
UEC 3xx for external safety	HSCI slave (PAE module integrated)	1 ³⁾

¹⁾ For more information on the NCK software, see the *Technical Manual* of the respective control.

²⁾ Total maximum of 1000 inputs/outputs and maximum of 10 PL units (PL, PLB, MB, TE)

³⁾ Only in systems without integrated functional safety (FS)

Basic principle

With controls with integrated functional safety (FS) from HEIDENHAIN, Safety Integrity Level 2 (SIL 2) as per the standard EN 61508 and Performance Level "d" Category 3 as per EN ISO 13849-1 can be attained. In these standards, the assessment of safety-related systems is based on, among other things, the failure probabilities of integrated components and subsystems. This modular approach aids the manufacturers of safety-related machines in implementing their systems, since they can then build upon prequalified subsystems. This design is taken into account for the CNC PILOT 640 control, as well as for safety-related position encoders. Two redundant, mutually independent safety channels form the basis of the controls with functional safety (FS). All safety-relevant signals are captured, processed, and output via two channels. Errors are detected through a reciprocal data comparison of the two channels' states. Consequently, the occurrence of a single error in the control does not cause a loss in safety functionality.

Design

The safety-related controls from HEIDENHAIN have a dual-channel design with mutual monitoring. The SPLC (safety-related PLC program) and SKERN (safety kernel software) software processes are the basis of the two redundant systems. The two software processes run on the MC main computer (CPU) and CC controller unit components. The dual-channel configuration through MC and CC is continued in the PLB 6xxx FS I/O systems and MB machine operating panel with FS (e.g., TE 725T FS). This means that all safety-relevant signals (e.g., permissive buttons, door contacts, emergency stop buttons) are captured via two channels, and are evaluated independently of each other by the MC and CC. The MC and CC use separate channels to also address the power modules, and to stop the motors in the event of an error.

Components

In systems with functional safety, certain hardware components handle safety-relevant tasks. In systems with FS, only safety-relevant components are permitted to be used that, including their variant from HEIDENHAIN, are approved for this.

Control components with functional safety (FS) are identifiable by the addition of "FS" after the type designation (e.g., TE 361 T FS).

For a current list of the components approved for functional safety (FS), refer to *Functional safety (FS) supplement to the Technical Manual* (ID 1177599).

MB and TE

An MB machine operating panel with functional safety is indispensable for systems with FS. Only on this MB do all the keys have a dual-channel design. Axes can be moved without additional permissive keys.

PLB	In systems with functional safety (FS), a combination of hardware (FS and standard) is possible, but a PLB 62xx FS is mandatory.
HR	In systems with functional safety (FS), FS handwheels are required because they are the only ones equipped with the required cross-circuit-proof permissive buttons.
Safety functions	<p>Safety functions integrated into hardware and software:</p> <ul style="list-style-type: none"> • Safe stop reactions (SS0, SS1, and SS2) • Safe torque off (STO) • Safe operating stop (SOS) • Safely limited speed (SLS) • Safely limited position (SLP) • Safe brake control (SBC) • Safe operating modes <ul style="list-style-type: none"> – Operating mode 1: Automatic or production mode – Operating mode 2: Set-up mode – Operating mode 3: Manual intervention – Operating mode 4: Advanced manual intervention, process monitoring <p>Please note: Full functionality is not yet available for all machine types with functional safety (FS). Before planning a machine with functional safety (FS), please determine whether the current range of features is sufficient for your machine design.</p>
Activation of functional safety (FS)	<p>The following requirements are absolutely necessary:</p> <ul style="list-style-type: none"> • At least one PLB 62xx FS must be present in the system • Safety-relevant control components in FS design (e.g., TE 725T FS, HR 550 FS) • Safety-related SPLC program • Configuration of safe machine parameters • Wiring of the machine for systems with functional safety (FS) <p>Functional safety (FS) can be scaled via software options 160 to 166 and 169 (see Page 14). Only the number of safe drive systems actually needed must be enabled.</p> <p>For every active drive that is assigned to a safe axis group, a safe control loop must be enabled. The control will otherwise display an error message.</p>
For more information	For details, see the <i>Functional Safety FS</i> Technical Manual. Your contact person at HEIDENHAIN will be glad to answer any questions concerning controls with functional safety (FS).

Control systems with external safety

Basic principle	<p>In control systems without integrated functional safety (FS), no integrated safety functions, such as safe operating modes, safe speed monitoring, or safe operating stop, are available. Such functions must be implemented entirely with the help of external safety components.</p> <p>Control systems without integrated functional safety (FS) solely support the realization of the safety functions STO (safe torque off: dual-channel interruption of the motor power supply) and SBC (safe brake control: dual-channel triggering of the motor holding brakes). The dual-channel redundancy of the functions must be realized by the OEM through appropriate wiring.</p>
Design	In control systems with external safety, a special PL module for the dual-channel triggering of STO and SBC is absolutely necessary. This module is the PAE-H 08-00-01, with which up to eight axis groups can be individually controlled.

Operating system

HEROS 5

The CNC PILOT 640 and PNC 610 work with the real-time-capable HEROS 5 operating system (HEIDENHAIN Realtime Operating System). This future-proof operating system contains the following powerful functions as part of its standard repertoire:

Network

- Network: management of network settings
- Remote Desktop Manager: management of remote applications
- Printer: management of printers
- Shares: management of network shares
- VNC: virtual network computing server

Safety

- Portscan (OEM): port scanner
- Firewall: protection against undesired network access
- SELinux: protection against unauthorized changes to system files
- Sandbox: running applications in separated environments

System

- Backup/Restore: function for backing-up and restoring the software on the control
- HLogging: evaluation and creation of log files
- Perf2: system monitor
- User administration: define users with different roles and access permissions

Tools

- Web browser: Firefox®*)
- Document Viewer: display PDF, TXT, XLSX and JPEG files
- File Manager: file explorer for managing files and memory media
- Gnumeric: spreadsheet calculations
- Leafpad: text editor for creating notes
- Ristretto: display of image files
- Orage Calendar: simple calendar function
- Screenshot: creation of screenshots
- Totem: media player for playing audio and video files

User administration

The improper operation of a control often leads to unplanned machine downtime and costly scrap. The user administration feature can significantly improve process reliability through the systematic avoidance of improper operation. Through the configurable linkage of rights with user roles, access can be tailored to the activities of the respective user.

- Logging on to the control with a user account
- User-specific HOME folder for simplified data management
- Role-based access to the control and network data



Axes

Overview

The CNC PILOT 640 is a contouring control for CNC lathes and is ideal both for horizontal and vertical lathes as well as vertical boring and turning mills. The CNC PILOT 640 supports lathes with a main and counter spindle, C axis or positionable spindle, and driven tools, as well as machines with Y and B axes. In multi-channel machining, different machining steps can be carried out simultaneously using several slides.

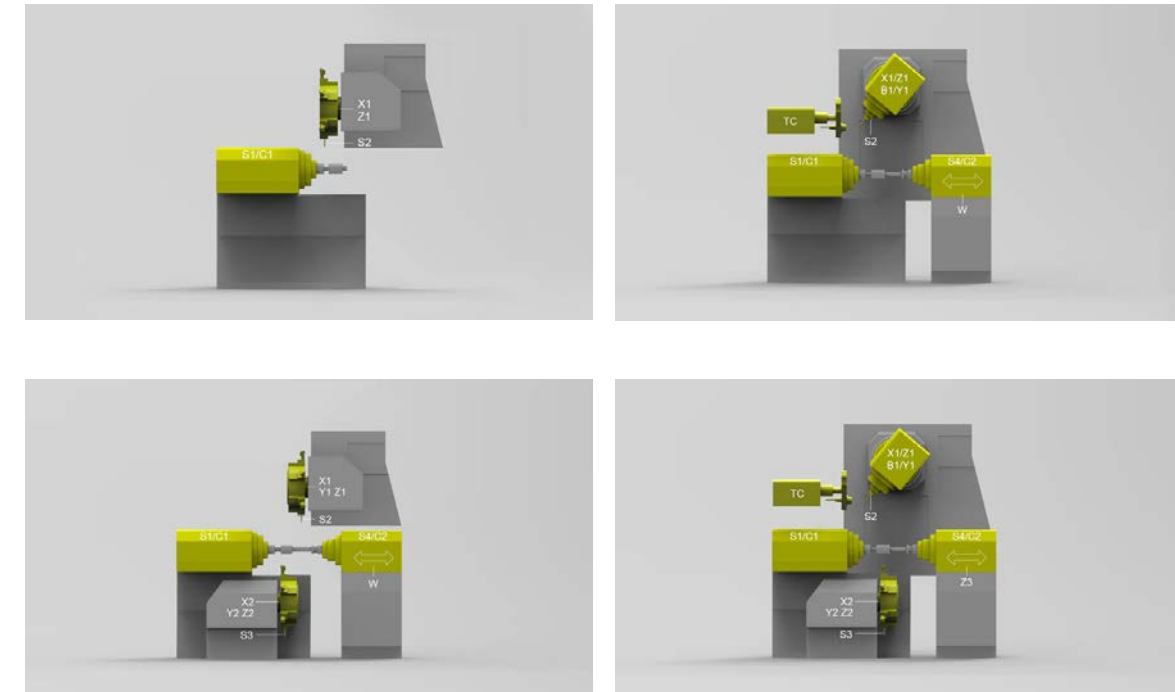

Display and programming

- Feed rate in
 - mm/min
 - mm/revolution
 - Feed rate override: 0 % to 150 %
 - Maximum feed rate at $f_{PVM} = 5000 \text{ Hz}$:

$$\frac{60000 \text{ rpm}}{\text{No. of motor pole pairs}} \cdot \text{Screw pitch [mm]}$$

Traverse range

-99999.9999 to +99999.9999 [mm]
The machine manufacturer defines the traverse range. The user can set additional limits to the traverse range if he wishes to reduce the working space (software limit switch). A protection zone for the spindle (Z-) can also be specified.

Tool carriers

The CNC PILOT 640 supports quick change tool posts (multifix), tool turrets, and tool magazines. The tool carriers can be located in front of or behind the workpiece.

*) Firefox is a registered trademark of the Mozilla Foundation

Synchronized axes

Synchronized axes move synchronously and are programmed with the same axis designation.

With HEIDENHAIN controls, parallel axis systems (gantry axes) such as on portal-type machines or tilting tables can be moved synchronously to each other through high-accuracy and dynamic position control.

In the case of **gantry axes**, multiple gantry slave axes can be assigned to a single master axis. They may also be distributed to multiple controller units.

B Axis (software option 54)

With a B axis it is possible to drill, bore, and mill in oblique planes. Programming can be done in the main plane as usual.

Moreover, by tilting the B axis and rotating the tool you can bring it into positions that enable you, for example, to use a single tool to machine in the longitudinal and transverse directions on the main and counter spindles. The number of required tools and tool changes can thus be reduced.

Torque Control (software option 24)

Torque control is used on machines with mechanically coupled motors, for which

- a defined distribution of drive torque is desired, or
- parts of the controlled system show a backlash effect that can be eliminated by "tensioning" the motors (e.g., toothed racks).

For torque control, the master and slave must be on the same controller motherboard. Depending on the controller unit being used, up to five slave axes can thereby be configured for each master.

Real-Time Coupling Function (software option 135)

The real-time coupling function (synchronizing functions) allows the cyclic calculation of a position offset for an axis from the actual and nominal values of any other axes in the system. This function allows complex, simultaneous movements of multiple NC or PLC axes to be implemented. The interdependencies of the axes are defined in mathematical formulas.

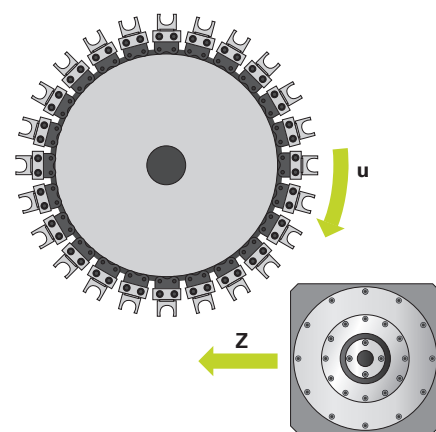
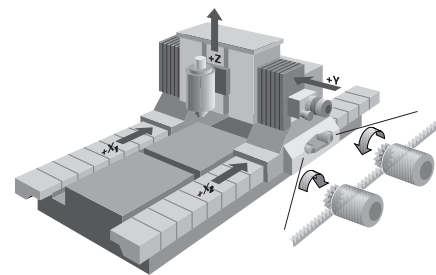
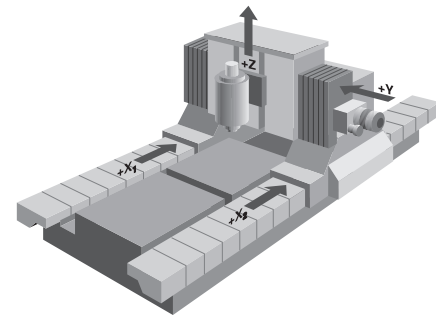

PLC axes

Axes can be defined as PLC axes. Programming is performed through M functions or OEM cycles. The PLC axes are positioned independently of the NC axes and are therefore designated as asynchronous axes.

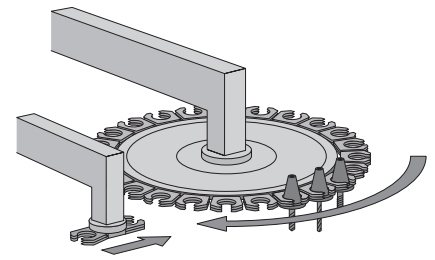

Multi-Channel Capability (software option 153)

Multi-channel machining provides up to three channels for asynchronous multi-slide machining. This is regardless of whether several slides simultaneously machine one workpiece or multiple workpieces in the workspace. Furthermore, with multi-channel machining the controlling of loading systems through a free machining channel is possible.

Main spindle and counter spindle

Overview	<p>The CNC PILOT 640 contouring control operates in conjunction with the HEIDENHAIN inverter systems with field-oriented control. As an alternative, an analog nominal speed value can be output.</p> <p>For machines featuring a higher level of automation, you can position the spindle or counter spindle, or switch to C-axis operation.</p>
Controller unit	<p>With the CC controller units and the UxC inverters, a fundamental PWM frequency can be set for each output. In this case, every output can have its own fundamental PWM frequency (e.g., with the CC 306: X551 = 4 kHz, X552 = 5 kHz, etc.).</p> <p>Possible fundamental frequencies are 3.33 kHz, 4 kHz, or 5 kHz.</p> <p>With software option 49 (Double Speed), this frequency can be increased to up to 16 kHz for fast-turning spindles (e.g., HF spindles).</p>
Display and programming	<p>Spindle speed:</p> <ul style="list-style-type: none">• Constant shaft speed: 1 to 99999 rpm• Constant surface speed: 1 to 9999 m/min
Spindle positioning	<p>Input resolution and display step: 0.001°</p>
Speed limiting	<ul style="list-style-type: none">• The CNC PILOT 640 monitors the actual speed.• Speed limiting can be adjusted via parameter and in the tool/spindle/feed-rate menu (TSF menu).
Spindle override	<p>50% to 150%</p>
Maximum spindle speed	<p>The maximum spindle speed is calculated as follows:</p> $n_{\max} = \frac{f_{\text{PWM}} \cdot 60000 \text{ rpm}}{\text{NPP} \cdot 5000 \text{ Hz}}$ <p>f_{PWM} = PWM frequency in Hz NPP = Number of pole pairs</p>
Gear ranges	<p>A specific parameter set can be defined for each gear range. The gears are switched via the PLC. Up to 10 gear ranges are supported.</p>
Operating mode switchover	<p>For controlling the spindle, different parameter sets can be saved for closed-loop control (e.g., for wye or delta connections). You can switch between the parameter sets in the PLC.</p>
Position-controlled spindle	<p>The position of the spindle is monitored by the control.</p>
Encoder	<p>HEIDENHAIN rotary encoder with sinusoidal voltage signals (1 V_{pp}) or EnDat interface.</p>
C-Axis Machining (software option 55)	<p>For milling, drilling, and boring cycles, either the spindle or counter spindle is switched to C-axis operation, or a separate C-axis drive is activated.</p> <p>Input resolution and display step: 0.001°</p>
Counter Spindle (software option 132)	<p>The Counter Spindle option is necessary in order to work with a counter spindle. The Spindle Synchronism option is included in the Counter Spindle option.</p>

Driven tools

Overview	<p>The driven tool is used for drilling and tapping holes as well as for milling in M19 or C-axis operation. Programs for the driven tool can be input in manual operation, via cycles with smart.Turn, or in the DIN editor.</p>
Display and programming	<p>Speed of the driven tool:</p> <ul style="list-style-type: none">• Constant shaft speed: 1 to 99999 rpm• Constant surface speed: 1 to 9999 m/min
Speed limiting	<ul style="list-style-type: none">• The CNC PILOT 640 monitors the actual speed.• Speed limiting can be adjusted via parameter and in the tool/spindle/feed-rate menu (TSF menu).
Spindle Synchronism (software option 131)	<p>The Spindle Synchronism option is necessary for special operations with a driven tool (e.g. polygonal turning.) This option is included in the Counter Spindle option.</p>

Encoders

Overview For speed and position control of the axes and spindle, HEIDENHAIN offers both incremental and absolute encoders.

Incremental encoders Incremental encoders have as their measuring standard a grating consisting of alternating lines and spaces. Relative movement between the scanning head and the scale causes the output of sinusoidal scanning signals. The measured value is calculated by counting the signals.

Reference mark After the machine has been switched on, the relationship between the measured value and the machine position must be established by traversing the reference marks. For encoders with distance-coded reference marks, the maximum travel until automatic reference mark storage for linear encoders is only 20 mm or 80 mm, depending on the model, or 10° or 20° for angle encoders.

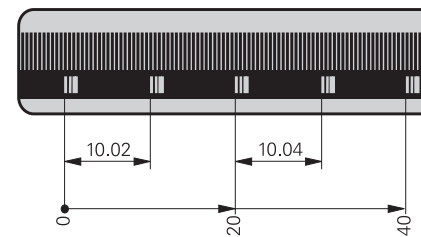

Evaluation of reference marks The routine for traversing the reference marks can also be started for specific axes via the PLC during operation (reactivation of parked axes).

Output signals Incremental encoders with sinusoidal output signals with ~ 1 V_{pp} levels are suitable for connection to HEIDENHAIN numerical controls.

Absolute encoders With absolute encoders, the position information is contained in several coded tracks. Thus, an absolute reference is available immediately after switch-on. Reference-mark traverse is not necessary. For cyclical closed-loop operation, position information from incremental signals can be used, or from serial absolute signals (EnDat 2.2) with very short cycles.

EnDat interface The CNC PILOT 640 features the serial EnDat 2.2 interface (includes EnDat 2.1) for the connection of absolute encoders.

Note: The EnDat interface on HEIDENHAIN encoders differs in its pin layout from the interface on Siemens motors with integrated absolute ECN/EQN rotary encoders. Special adapter cables are available.

Encoder inputs Incremental and absolute linear, angle, or rotary encoders from HEIDENHAIN can be connected to the **encoder** inputs of the controller unit (only purely serial encoders with EnDat 2.2 can be connected to mini-IO connectors).

Channel inputs	Signal level/ Interface ¹⁾	Input frequency ¹⁾	
		Position	Speed
Incremental signals	~1 V _{pp} EnDat 2.1	33 kHz/350 kHz	350 kHz
Absolute position values	EnDat 2.1 EnDat 2.2	–	–

¹⁾ Switchable

Digital servo control

Integrated inverter HEIDENHAIN synchronous or asynchronous motors are connected to the CNC PILOT 640.

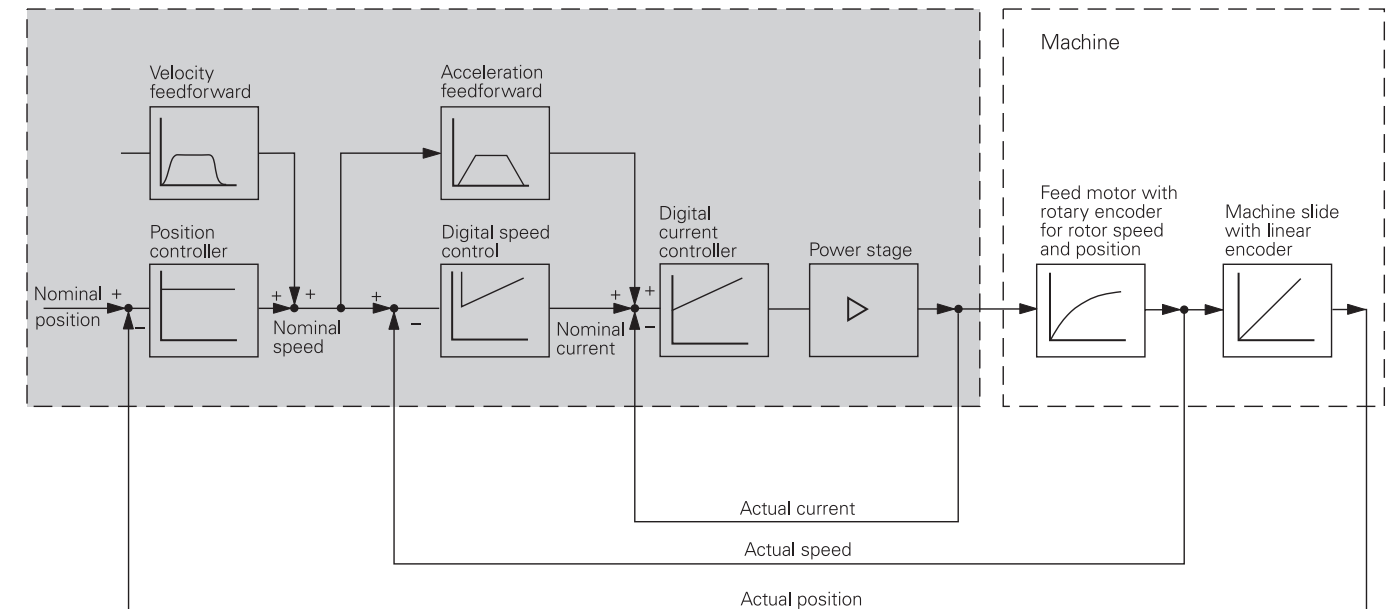

Axis feedback control The CNC PILOT 640 can be operated with feedforward control or servo lag.

Operation with feedforward control Feedforward means that a given velocity and acceleration are adapted to the machine. Together with the values calculated from the servo lag, this given velocity and acceleration becomes the nominal value. A much lower servo lag thereby manifests itself.

Operation with servo lag The term "servo lag" denotes the distance between the momentary nominal position and the actual position of the axis. The velocity is calculated as follows:

$$v = k_v \cdot s_a$$

v = Velocity
 k_v = Position loop gain
 s_a = Servo lag

Compensation of torque ripples The torque of synchronous, torque, and linear motors is subject to periodic oscillations, one cause of which can be permanent magnets. The amplitude of this torque ripple depends on the motor design and, under certain circumstances, can have an effect on the workpiece surface. During initial configuration of the axes with TNCopt, this "torque ripple" can be compensated for by means of the Torque Ripple Compensation (TRC) function of the CC or UEC.

Control-loop cycle times

The cycle time for **path interpolation** is defined as the time interval during which interpolation points on the path are calculated. The cycle time for **fine interpolation** is defined as the time interval during which interpolation points are calculated that lie within the interpolation points calculated for path interpolation. The **cycle time for the position controller** is defined as the time interval during which the actual position value is compared to the calculated nominal position value. The **cycle time for the speed controller** is the time interval in which the actual speed value is compared to the calculated nominal speed value. The **cycle time for the current controller** is defined as the time interval during which the actual value of the electrical current is compared to the calculated nominal value of the electrical current.

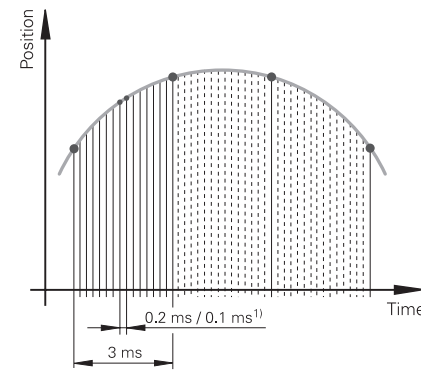

	CC/UEC/UMC
Path interpolation	See values at Page 6
Fine interpolation	
Position controller	
Speed controller	
Current controller	

Axis clamping

The control loop can be opened through the PLC in order to clamp specific axes.

Double-Speed Control Loops (software option 49)

Double-speed control loops permit higher PWM frequencies and shorter cycle times for the speed controller. This enables improved current control for spindles and higher controller performance for linear and torque motors.

Crossover Position Filter (CPF)

To increase the stability of the position control loop in systems with resonances, the position signal from the position encoder, which is filtered through a low-pass filter, is combined with the position signal from the motor speed encoder, which is filtered through a high-pass filter. This signal combination is made available to the position controller as the actual position value. The possible position controller gain (k_v factor) is increased significantly by this. The filter separation frequency is set specifically for each axis via machine parameters. The CPF can be used only in dual-encoder systems; i.e., on motors with a speed encoder and position encoder.

Fast machining

Look-ahead

The CNC PILOT 640 calculates the geometry ahead of time in order to adjust the feed rate. In this way, directional changes are detected in time to accelerate or decelerate the appropriate NC axes.

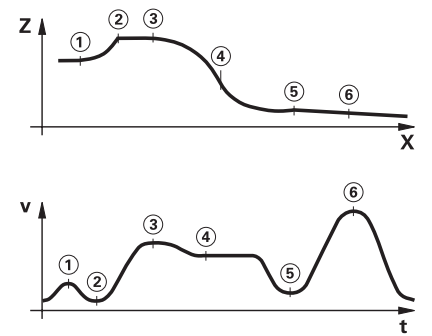

Jerk

The derivative of acceleration is referred to as jerk. A linear change in acceleration causes a jerk step. Such motion sequences may cause the machine to oscillate.

Jerk limiting

To prevent machine oscillations, the jerk is limited in order to attain optimum path control.

Smoothed jerk

The jerk is smoothed by nominal position value filters. The CNC PILOT 640 therefore mills smooth surfaces at the highest possible feed rate and yet keeps the contour accurate. The permitted tolerance is programmed by the user via a cycle. Special filters for HSC machining (HSC filters) can suppress machine-specific natural frequencies. The desired accuracy along with very high surface quality is attained.

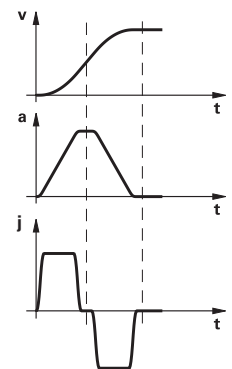

Advanced Dynamic Prediction (ADP)

The Advanced Dynamic Prediction (ADP) function enhances the look-ahead of the permissible maximum feed rate profile, thereby enabling optimized motion control for clean surface finishes and perfect contours. The strengths of ADP are evident, for example, during bidirectional finish milling through symmetrical feed behavior on the forward and reverse paths as well as through particularly smooth feed rate curves on parallel milling paths. NC programs that are generated on CAM systems have a negative effect on the machining process due to various factors such as short, step-like contours; coarse chord tolerances; and heavily rounded end-point coordinates. Through an improved response to such factors and the exact adherence to dynamic machine parameters, ADP not only improves the surface quality of the workpiece but also optimizes the machining time.

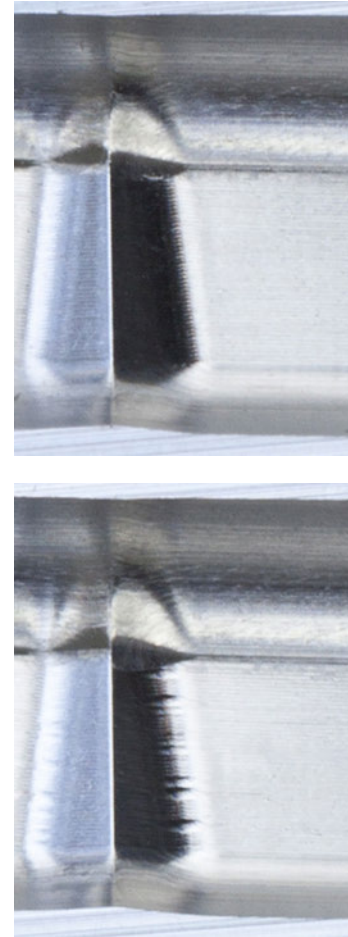

Top figure: part milled with ADP
Bottom figure: part milled without ADP

Monitoring functions

Description

During operation the control monitors the following factors, among others*):

- Amplitude of encoder signals
- Edge separation of encoder signals
- Absolute position for encoders with distance-coded reference marks
- Current position (servo lag monitoring)
- Actual path traversed (movement monitoring)
- Position deviation at standstill
- Nominal speed value
- Checksum of safety-related functions
- Supply voltage
- Voltage of the buffer battery
- Operating temperature of MC and CPU
- Run time of PLC program
- Motor current / motor temperature
- Temperature of power module
- DC-link voltage
- Difference between position and speed encoder (PosDiff)
- Serial connection of all devices in the HSCI chain
- Quality of optical connections between CC and UM
- Voltages of the main power supply
- Utilization of the 24 V supply

With EnDat 2.2 encoders:

- CRC checksum of the position value
- EnDat alarm Error1 → EnDat status alarm register (0xEE)
- EnDat alarm Error2
- Edge speed of 5 μ s
- Transmission of the absolute position value on the time grid

In the event of hazardous errors, an EMERGENCY STOP message is sent to the external electronics via the control-is-ready output, and the axes are brought to a stop. The correct connection of the CNC PILOT 640 in the machine's EMERGENCY STOP loop is checked when the control system is switched on. In the event of an error, the control displays a message in plain language.

*) No safety functions

Context-sensitive help A context-sensitive help function is available to the user via the ERR key or the Info key or soft key. In the event of an error message, the control displays the cause of the error and the possibilities for fixing it. The machine manufacturer can also implement this user support for PLC error messages.

Load Monitoring (software option 151) This option monitors the load that occurs during machining processes in order to detect the wear or breakage of tools. By performing a reference operation for each machining step, the nominal load on the motors is determined. The actual motor load is then continuously compared to the nominal load. Up to four motors can be monitored per machining step. In the event of tool wear or breakage, two definable limit values trigger error reactions.

Tool wear If the load and/or load integral exceed the limit values for tool wear, the CNC PILOT 640 designates the current tool as worn. With active tool life monitoring, the tool will automatically be replaced by a defined replacement tool the next time it is called.

Tool breakage If the load exceeds the limit value for tool breakage, the CNC PILOT 640 immediately stops machining (cycle stop).

Meaningful error messages are issued if the limit values are exceeded. Furthermore, the CNC PILOT 640 can display the load values numerically and graphically in a separate window.

Component Monitoring (software option 155) The overloading of machine components is often the cause of expensive machine damage and unplanned production downtime. Component monitoring keeps the user informed about the current load on the spindle bearings and reacts upon exceedance of the specified limit values (e.g., with an NC stop).

During their lifecycle, the machine components that are subject to loads (e.g., guides, ball screws, etc.) become worn and thus the quality of the axis movements deteriorates. This, in turn, affects production quality. With Component Monitoring (option 155) and a cycle, the control is able to measure the current condition of the machine. As a result, any deviations from the machine's shipping condition due to wear and aging can be measured. The machine manufacturer can read and evaluate the data, and react using predictive maintenance, thereby avoiding unplanned machine downtime.

Error compensation

Overview The CNC PILOT 640 automatically compensates for mechanical errors of the machine.

Linear error Linear error can be compensated for each axis over their entire travel range.

Nonlinear error The CNC PILOT 640 can compensate for ball-screw pitch errors and sag errors simultaneously. The compensation values are stored in a table. Nonlinear axis-error compensation also makes it possible to compensate for position-dependent backlash.

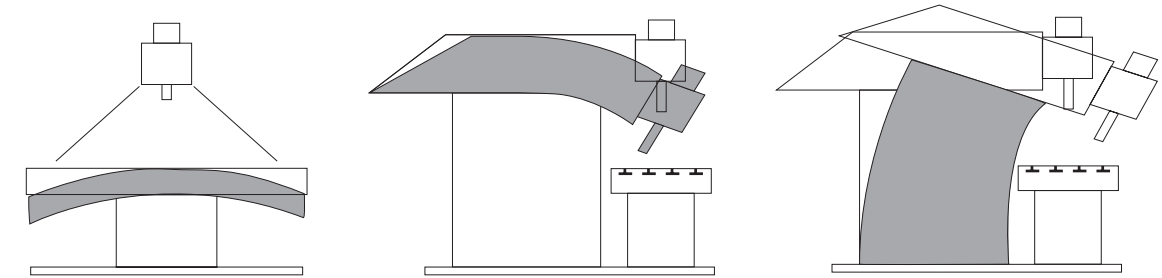

Backlash The play between table movement and rotary encoder movement during direction changes can be compensated for in length measurements by the spindle and rotary encoder. This backlash is outside the controlled system.

Hysteresis The hysteresis between the table movement and motor movement is also compensated for in direct length measurements. In this case, the hysteresis is within the controlled system.

Reversal spikes In circular movements, reversal spikes can occur at quadrant transitions due to mechanical influences. The CNC PILOT 640 can compensate for these reversal spikes.

Static friction At very low feed rates, high static friction can cause the slide to stop and start repeatedly for short periods. This is commonly known as stick-slip. The CNC PILOT 640 can compensate for this problematic behavior.

Sliding friction Sliding friction is compensated for by the speed controller of the CNC PILOT 640.

Thermal expansion To compensate for thermal expansion, the machine's expansion behavior must be known.

The temperature is measured via thermistors connected to the analog inputs of the CNC PILOT 640. The PLC evaluates the temperature information and passes a compensation value to the NC.

Load Adaptive Control (LAC, software option 143) With LAC (software option 143), you can dynamically adjust controller parameters based on the load or friction.

In order to optimize changed control behavior at differing loads, various controller parameters (e.g., loop gains, and feedforward controls for acceleration, holding torque, static friction, and friction at high shaft speeds) can be adapted to the currently active load.

Initial setup and diagnostic aids

Overview The CNC PILOT 640 provides extensive internal aids for diagnostics and initial setup. It also includes highly effective PC software for diagnostics, optimization, and remote operation.

ConfigDesign (accessory) PC software for configuring the machine parameters

- Stand-alone machine-parameter editor for the control; all support information, additional data, and input limits are shown for the parameters
- Configuration of machine parameters
- Comparison of parameters from different controls
- Importing of service files: easy testing of machine parameters in the field
- Rule-based creation and management of machine configurations for multiple controls (together with PLCdesign)

TNCdiag The HEIDENHAIN TNCdiag application evaluates the status and diagnostic information of HEIDENHAIN components (with an emphasis on the drive systems) and graphically images the data:

- Status and diagnostic information about the HEIDENHAIN components (drive electronics, encoders, input/output devices, etc.) connected to the control
- History of the recorded data

TNCdiag comes in a PC version for the analysis of servicing files and in a control version for the display of real-time data.

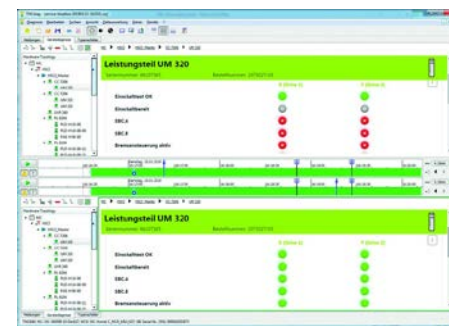

Oscilloscope The CNC PILOT 640 features an integrated oscilloscope. Both X/t and X/Y graphs are possible. The following characteristic curves can be recorded and stored in six channels:

- Actual value and nominal value of the axis feed rate
- Contouring feed rate
- Nominal and actual position
- Servo lag of the position controller
- Content of PLC operands
- Encoder signal (0° – A) and (90° – B)
- Difference between position and speed encoder
- Nominal velocity value
- Integral-action component of the nominal current value
- Torque-determining nominal current value

Logic signals Simultaneous graphic representation of the logic states of up to 16 operands (markers, words, inputs, outputs, counters, timers)

- Marker (M)
- Input (I)
- Output (O)
- Timer (T)
- Counter (C)
- IpoLogik (X)

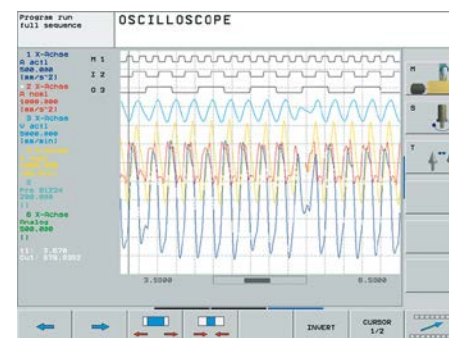

TNCopt (accessory) PC software for initial setup of digital control loops. Functions (among others):

- (Automatic) initial setup of the control loops (current, speed, position)
- (Automatic) optimization of various feedforward controls
 - Reversal peaks
 - Friction parameters, acceleration feedforward control
 - Torsion compensation
- (Automatic) system identification
- Circular form test, contour test
- Working space scan, 3D workspace inspector

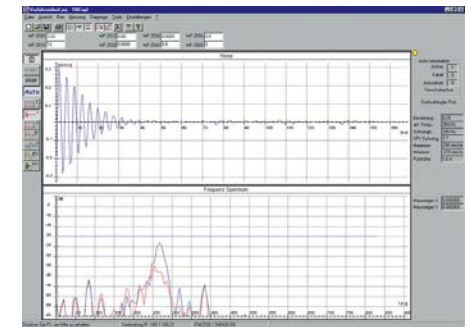

Online Monitor (OLM) The online monitor is a component of the CNC PILOT 640 and is called with a code number. It supports initial setup and diagnosis of control components through the following:

- Display of control-internal variables for axes and channels
- Display of controller-internal variables (if a CC is present)
- Display of hardware signal states
- Various trace functions
- Activation of spindle commands
- Enabling of control-internal debug outputs

TNCscope (accessory) PC software for transferring the oscilloscope files to a PC. With TNCscope you can record and save up to 32 channels simultaneously.

API DATA With the API DATA function, the control displays the states or contents of the symbolic API markers and API double words.

Table function The current conditions of the markers, words, inputs, outputs, counters, and timers are displayed in tables. The conditions can be changed through the keyboard.

Trace function The current content of the operands and the accumulators is shown in the statement list in each line in hexadecimal or decimal code. The active lines of the statement list are marked.

Log For the purpose of error diagnostics, all error messages and keystrokes are recorded in a log. The entries can be read using the **PLCdesign** or **TNCremo** software for PCs.

RemoteAccess (accessory)

PC software for remote diagnostics, monitoring and operation.

RemoteAccess grants quick and easy access to HEIDENHAIN controls that are installed within the same local network (intranet).

RemoteAccess offers the following functions:

- Display of the control's user interface on the PC
- Operating the control directly through the live view as well as with the integrated keyboard
- Automatic integraton of HEIDENHAIN PC tools
- Can be enhanced with OEM-specific applications

Single-station license	ID 1339577-01
Network license (14 stations)	ID 1339577-02
Network license (20 stations)	ID 1339577-03

Secure Remote Access (SRA)

The optional Secure Remote Access enhancement makes it possible to establish an encrypted connection with a HEIDENHAIN control via the internet. This connection is end-to-end encrypted. Once the SRA connection has been set up, RemoteAccess behaves like a local network connection. This connection can be used by HEIDENHAIN PC tools and by any other PC application.

Possible applications when using SRA:

- User support
- Online training courses
- Diagnostics, remote maintenance and online support
- Secure internet connection as the basis for other OEM services

Export license required

The Secure Remote Access expansion requires an export license in accordance with Annex I of the EU Dual-Use Regulation. A valid export license is mandatory for operating this application outside of the EU or with partners outside of the EU.

License model

The expansion is offered as a software subscription with a two-year license period. The license term is automatically renewed for twelve months unless the contract is terminated with at least three months' notice. The license requires a HEIDENHAIN Portal account.

Scope of delivery

A license key is included in order to enable the Secure Remote Access expansion. During activation in the HEIDENHAIN Portal, the license key is assigned to the registered user.

Secure Remote Access (SRA)	ID 1356741-01
Software subscription (2-year license term)	

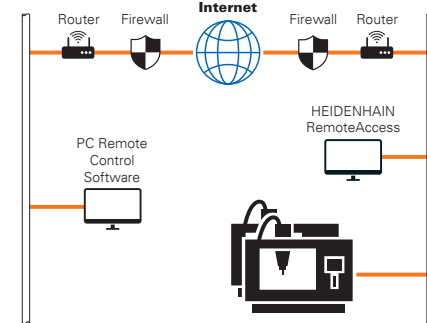

Bus diagnosis

In Diagnosis mode, the structure of the connected bus systems as well as the details of the connected components can be shown in an intuitive manner.

TNCtest

Acceptance tests on machine tools with external or integrated functional safety (FS) must be conducted reproducibly and verifiably.

The TNCtest and TestDesign program package can be used to plan and perform acceptance tests on machine tools with HEIDENHAIN controls. The acceptance tests are planned with TestDesign and run with TNCtest.

The TNCtest programs are designed to provide support during acceptance testing, provide required information, and perform automatic configuration, as well as record data and evaluate the data semiautomatically. A tester must evaluate manually whether a test case passed or failed.

TNCAnalyzer

The TNCAnalyzer application from HEIDENHAIN provides for simple and intuitive evaluation of servicing and log files:

- Loading of servicing and log files
- Analysis of temporal sequences and static states
- Filters and search functions
- Data export (HELogger, CSV, and JSON formats)
- Definition of application-specific analysis profiles
- Preconfigured analysis profiles
- Graphic display of signals via TNCscope
- Interaction with other tools that are intended for the display of special sections of the service file

Integrated PLC

Overview The PLC program is created by the machine manufacturer either on the control or with the PLC development software **PLCdesign** (accessory). Machine-specific functions are activated and monitored via the PLC inputs/outputs. The number of PLC inputs/outputs required depends on the complexity of the machine.

PLC inputs/outputs PLC I/Os are available via the external PL 6000 and UxC. The PLC I/Os and the PROFINET IO or PROFIBUS DP-capable I/O system must be configured with the IOconfig PC software.

PLC programming	Format	Statement list
	Memory	4 GiB
	Cycle time	9 ms to 30 ms (adjustable)
	Command set	<ul style="list-style-type: none"> • Bit, byte, and word commands • Logical operations • Arithmetic commands • Comparisons • Bracketed terms • Jump commands • Subprograms • Stack operations • Submit programs • Timers • Counters • Comments • PLC modules • Strings

Encryption of PLC data The encrypted PLC partition (PLCE:) provides the machine manufacturer with a tool for preventing third parties from viewing or changing files. The files on the PLCE partition can be read only by the control itself or by using the correct OEM keyword. This ensures that proprietary know-how and special customer-specific solutions cannot be copied or changed.

The machine manufacturer can also determine the size of the encrypted partition. This is not determined until the machine manufacturer creates the PLCE partition. Another advantage is that, in spite of the encryption, the data can be backed up from the control to a separate data medium (USB drive or network, e.g., through TNCremo) and later restored. You need not enter the password, but the data cannot be read until the keyword is supplied.

PLC window The CNC PILOT 640 can display PLC error messages in the dialog line during operation.

PLC soft keys The machine manufacturer can display his own PLC soft keys in the vertical soft-key row on the screen.

PLC positioning All closed-loop axes can also be positioned via the PLC. PLC positioning of the NC axes cannot be superimposed on NC positioning.

PLC axes Axes can be defined as PLC axes. They are programmed by means of M functions or OEM cycles. The PLC axes are positioned independently of the NC axes.

PLCdesign (accessory) PC software for PLC program development. The PC program **PLCdesign** can be used for easy creation of PLC programs. Extensive examples of PLC programs are included.

Functions:

- User-friendly text editor
- Menu-guided operation
- Programming of symbolic operands
- Modular programming techniques
- "Compiling" and "linking" of PLC source files
- Operand commenting, creation of the documentation file
- Comprehensive help system
- Data transfer between the PC and control
- Creation of PLC soft keys

Python OEM Process (software option 46) The Python OEM Process software option gives the machine manufacturer a powerful tool for using a high-level, object-oriented programming language in the control (PLC). Python is an easy-to-learn script language supporting all necessary high-level language elements.

Python OEM Process can be employed universally for machine functions, complex calculations, and the display of special user interfaces. User-specific or machine-specific solutions can be efficiently implemented. Numerous libraries on the basis of Python and GTK are available, regardless of whether you want to create special algorithms for special functions, or separate solutions such as an interface for machine maintenance software.

The applications you create can be included via the PLC in the familiar PLC windows, or they can be displayed in separate free windows that can be expanded to the control's full screen size.

Simple Python scripts can also be executed without enabling Python OEM Process (software option 46). Reserved for this function are 10 MB of dedicated memory. For more information, refer to the *Python in HEIDENHAIN Controls Technical Manual*.

PLC basic program The PLC basic program serves as the basis for the adaptation of the control to the requirements of the respective machine model. It can be downloaded from the Internet. These essential functions are covered by the PLC basic program:

- General information
- Vertical PLC soft-key row
 - Support for various screen formats
 - Display and management of PLC error messages
 - Hydraulic control
 - Work envelope protection
 - Chuck protection
 - Chuck (inner and outer chucking for compression and tension fixtures)
 - Control of the coolant system (internal, external, air)
 - Handling of M functions
 - Chip conveyor
 - PLC support for handwheels
 - PLC log
 - Diagnostic screen (Python)
 - Python example applications
 - Status display is modifiable by the user in the dashboard area (Python widget)
 - Tailstock (coupled Z axis) with quill

- System
- 3 channels for multi-slide machining
 - 5-axis machining milling/turning with B axis

- Axes
- Control of analog and digital axes
 - Axes with clamping mode, central drive, and the Hirth grid
 - Synchronized axes
 - Reference run, reference end position
 - Feed rate control
 - Axis lubrication
 - Temperature compensation

- Spindles
- Control of analog and digital spindles (S1 to S5)
 - Spindle synchronism for main and counter spindles (S1/S4)
 - Torque reduction for workpiece transfer (S1/S4)
 - Oriented spindle stop
 - Spindles with clamping mode
 - Gear switching via M functions
 - C-axis operation of spindles (S1/S4)
 - C-axis operation via separate motor

- Tool changers
- Manual tool changer
 - Tool change with multifix
 - Positioning of the tool turret with three-phase AC motor
 - Tool changer with revolver system (five types, multi-channel)
 - Tool changer with B axis, tool gripper, tool shuttle, and n tool magazines
 - Service functions for the tool changer (multi-channel)

- Safety functions
- Functional safety (FS)
 - Emergency stop test (EN 13849-1)
 - Brake test (EN 13849-1)
 - Repeated switch-on test

Interfacing to the machine

OEM cycles Machine manufacturers can create their own units for programming in smart.Turn (menus, texts, dialogs and evaluations). These units can be called by a menu item in the unit menu.

With the CNC PILOT 640 you can create your own manufacturer cycles (OEM G functions). The range G500 to G590 is intended for these G functions. They can be called via the G-function menu and integrated directly into the NC program.

In addition to the OEM G functions, PLC G functions (G602 to G699) can also be defined. The PLC G functions are processed directly in the PLC.

Tool management With the built-in PLC, the tool changer is moved either via proximity switch or as a controlled axis. Complete tool management with tool life monitoring and replacement tool monitoring is carried out by the CNC PILOT 640.

Tool measurement With the TT tool touch probes (accessory), tools can be measured and inspected. Standard cycles for automatic tool measurement are available in the control. The control calculates the probing feed rate and the optimal spindle speed. The measured data are stored in a tool table.

Touch-probe configuration All touch-probe data can be configured conveniently through the touch-probe table. All HEIDENHAIN touch probes are preconfigured and can be selected through a drop-down menu.

Magazine management The magazine management provides several functions for various magazine types:

- Loading and unloading of tools in chain-type magazines
- Loading and unloading between magazine and spindle
- Support for manual tools in manual magazines
- Support for block search in tool magazines

Data transfer and communication

Data interfaces

Overview	The CNC PILOT 640 is connected to PCs, networks, and other data storage devices via data interfaces.	
Ethernet	Using the Ethernet data interface, you can network the CNC PILOT 640 based on the TCP/IP protocol. For connection to the data network, the control features a 1000BASE-T (twisted pair Ethernet) connection. Maximum transmission distance: Unshielded: 100 m Shielded: 400 m	
Network connection	<ul style="list-style-type: none">• NFS file server• Windows networks (SMB)	
Data transfer speed	Approx. 400 to 800 Mbit/s (depending on the file type and network utilization)	
Protocols	The CNC PILOT 640 can transfer data using various protocols.	
Standard data transfer	The data is transferred character by character. The number of data bits, stop bits, the handshake, and character parity must be set by the user.	
Blockwise data transfer	The data is transferred blockwise. A block check character (BCC) is used for data backup. This method improves data security.	
USB	The CNC PILOT 640 features USB ports for connecting standard USB devices such as a mouse, disk drive, etc. The MCs have four USB 3.0 ports. One of them leads to the TE, where a cover cap protects it from contamination. More USB 2.0 ports are in the integrated USB hub on the rear of the BF. The USB ports are rated for a maximum of 0.5 A.	
USB cables	Cable length up to 5 m	ID 354770-xx
	Cable length 6 m to 30 m with integrated amplifier; limited to USB 1.1.	ID 624775-xx

Software for data transfer We recommend using HEIDENHAIN software to transfer files between the CNC PILOT 640 and a PC.

TNCremo (accessory) This PC software package supports the user in transferring data from the PC to the control. This software implements blockwise data transfer with block check characters (BCC).

Functions:

- Data transfer (including blockwise)
- Remote control (only serial)
- File management and data backup of the control
- Reading out the log
- Print-out of screen contents
- Text editor
- Managing more than one machine

TNCremoPlus (accessory) In addition to the features already familiar from TNCremo, TNCremoPlus can also transfer the current content of the control's screen to the PC (live screen). This makes it very simple to monitor the machine.

Additional functions:

- Interrogation of control information (NC up time, machine up time, machine running time, spindle running time, pending errors, data from the data servers—e.g., symbolic PLC operands)
- Overwriting of specific tool data based on values from a tool presetter

TNCremoPlus

ID 340447-xx

Connected Machining

Overview

Connected Machining makes uniformly digital job management possible in networked manufacturing. You also profit from:

- Easy data usage
- Time-saving procedures
- Transparent processes

Remote Desktop Manager (software option 133)

Remote operation and display of external computers over an Ethernet connection (e.g., Windows PC). The information is displayed on the control's screen. Remote Desktop Manager allows you to access important applications, such as CAD/CAM applications or job management, from the control.

Remote Desktop Manager ID 894423-xx

HEIDENHAIN DNC (software option 18)

The development environments on Windows operating systems are particularly well suited as flexible platforms for application development in order to come to terms with the increasingly complex requirements of the machine's environment.

The flexibility of the PC software and the large selection of ready-to-use software components and standard tools in the development environment enable you to develop PC applications of great use to your customers in a very short time, for example:

- Error reporting systems that, for example, send the customer a text message to his cell phone reporting problems on the currently running machining process
- Standard or customer-specific PC software that decidedly increases process reliability and equipment availability
- Software solutions controlling the processes of manufacturing systems
- Information exchange with order management software

The HEIDENHAIN DNC software interface is an attractive communication platform for this purpose. It provides all the data and configuration capabilities needed for these processes so that an external PC application can evaluate data from the control and, if required, influence the manufacturing process.

RemoTools SDK (accessory)

To enable you to use HEIDENHAIN DNC effectively, HEIDENHAIN offers the RemoTools SDK development package. It contains the COM component and the ActiveX control for integration of the DNC functions in development environments.

RemoTools SDK ID 340442-xx

For more information, refer to the *HEIDENHAIN DNC* brochure.

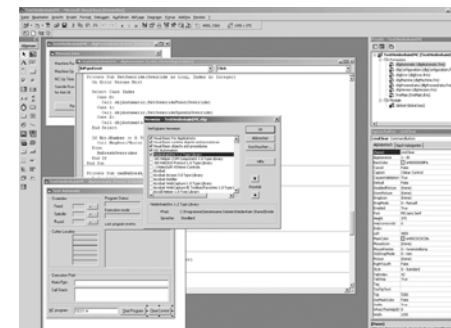
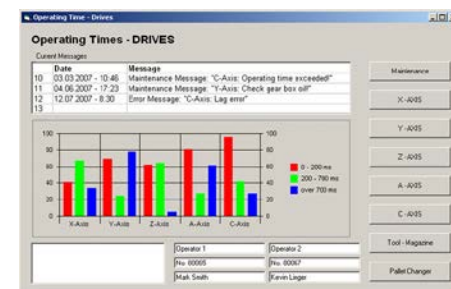

Mounting information

Clearances and mounting

Proper minimum clearance

When installing the control components and power modules, take note of the minimum spacing, space needed for servicing, and the appropriate length and location of the connecting cables as detailed in the Technical Manual of the CNC PILOT 640.

Mounting and electrical installation

Observe the following points during mounting and electrical connection:

- National regulations for low-voltage installations at the operating site of the machine or components
- National regulations regarding interference and noise immunity at the operating site of the machine or components
- National regulations regarding electrical safety and operating conditions at the operating site of the machine or components
- Specifications for the installation position
- Specifications of the Technical Manual

Degrees of protection

The following components fulfill the requirements for IP54 (dust protection and splash-proof protection):

- Display unit (when properly installed)
- Keyboard unit (when properly installed)
- Machine operating panel (when properly installed)
- Handwheel

All electric and electronic control components must be installed in an environment (e.g., electrical cabinet, housing) with an IP54 rating (dust and splash-proof protection) in order to fulfill the requirements of pollution degree 2. All components of the OEM operating panel must also have an IP54 rating, just like the HEIDENHAIN operating panel components.

Electromagnetic compatibility

Protect your equipment from interference by observing the rules and recommendations specified in the Technical Manual.

Intended place of operation

The units comply with EN 50370-1 and EN 61800-3, and are intended for use in industrially zoned areas.

Likely sources of interference

Interference is produced by capacitive and inductive coupling into electrical conductors or into device connections. This is caused, for example, by:

- Strong magnetic fields from transformers or electric motors
- Relays, contactors, and solenoid valves
- High-frequency equipment, pulse equipment, and switch-mode power supplies
- Power lines and leads to the above equipment

Protective measures

- Ensure that the MC, CC, and signal lines are at least 20 cm away from interfering devices
- Minimum distance of 10 cm between MC, CC, and signal lines to cables carrying interfering signals (in metal cable ducts, a grounded separation wall suffices for decoupling)
- Shielding by means of closed, grounded metal enclosures (e.g., an electrical cabinet)
- Use equipotential bonding lines in accordance with the grounding diagram (comply with the Technical Manual of your control).
- Use only genuine HEIDENHAIN cables and connecting elements

Installation elevation

The maximum elevation for installation of HEIDENHAIN control components (MC, CC, PLB, MB, TE, BF, IPC, etc.) is 3000 m above sea level.

Key dimensions

Main computer

MC 306, IPC 306

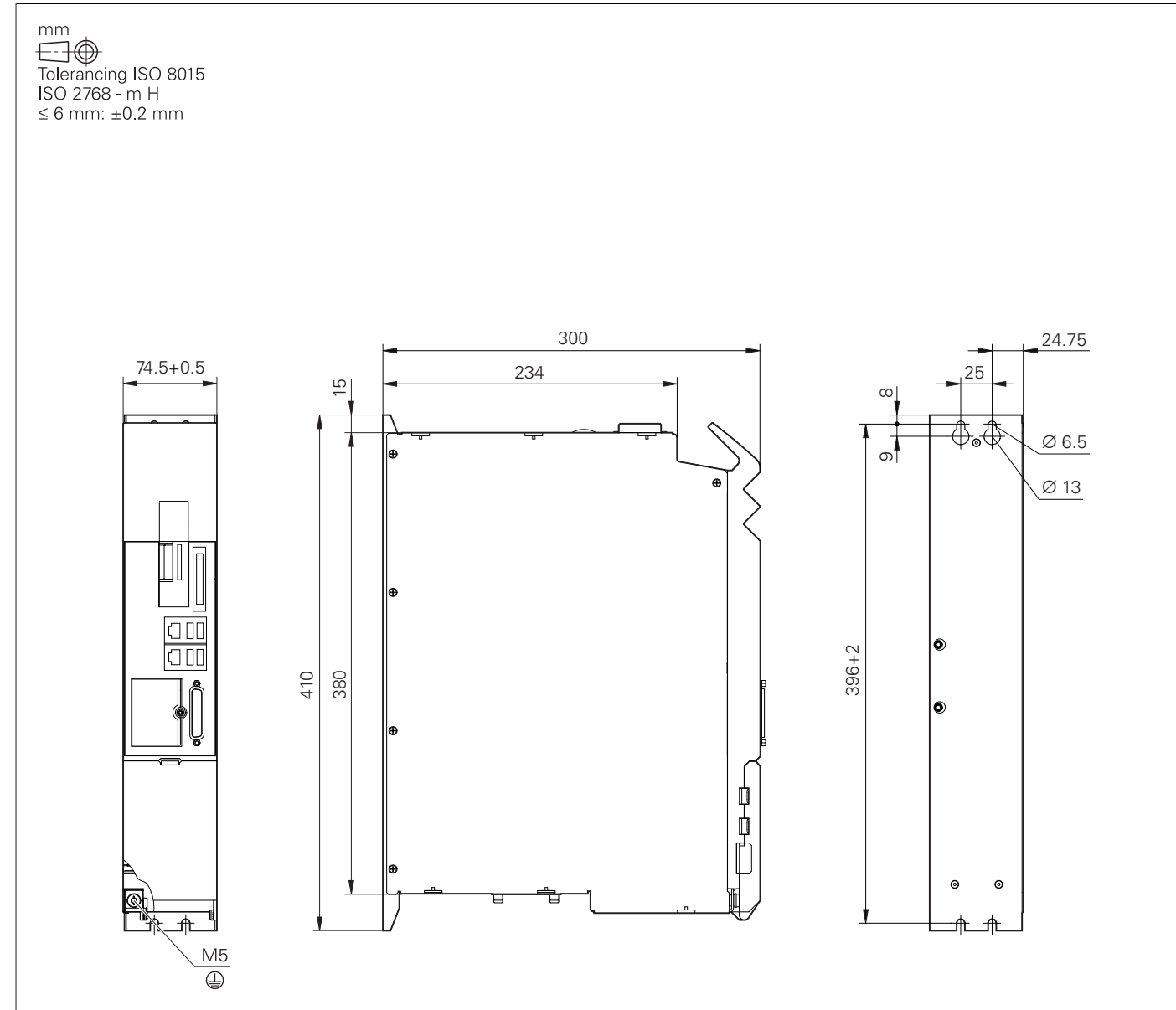

IPC 6490

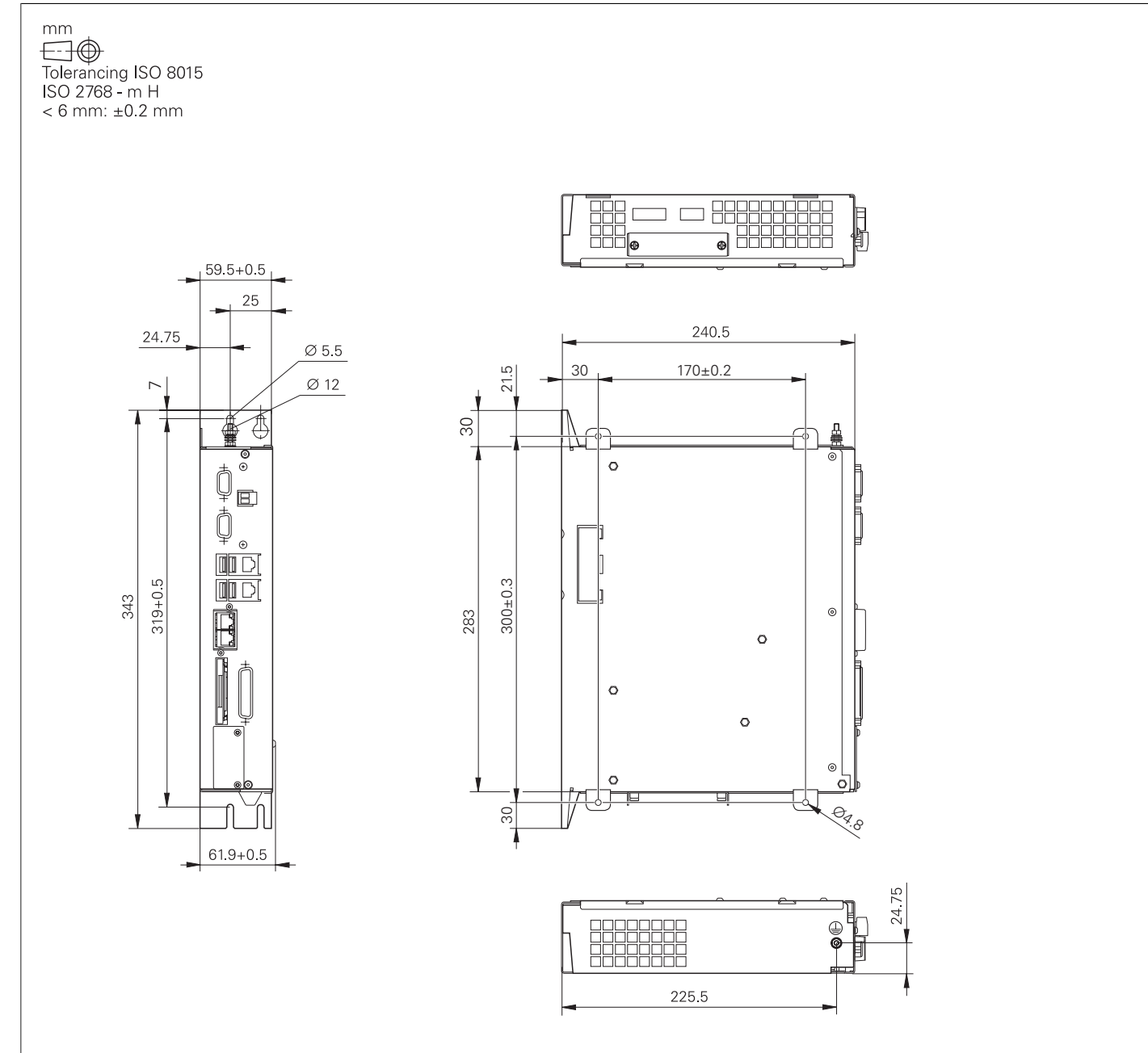

MC 8420T, IPC 8420

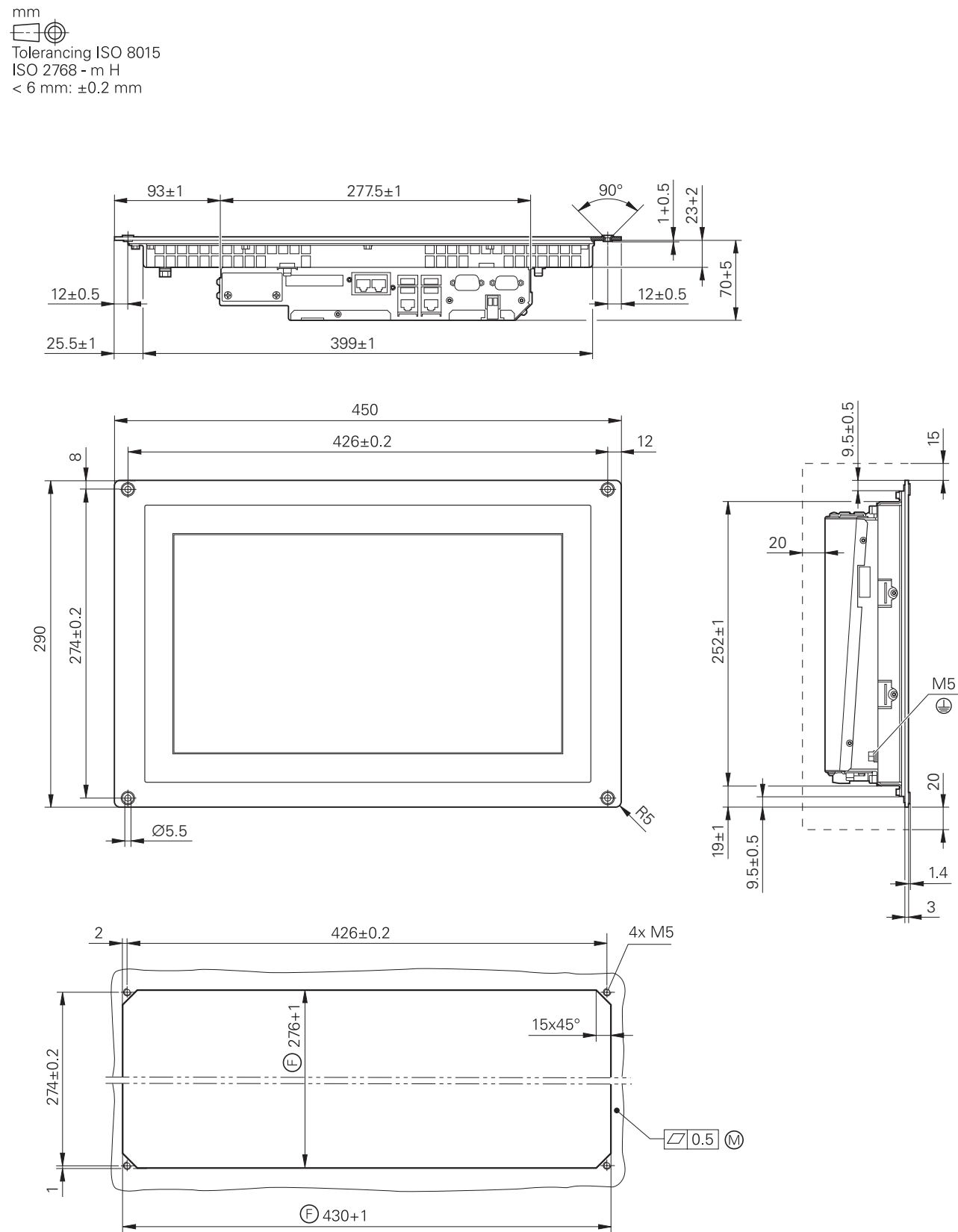

- ⊕ = Front panel opening
- Ⓜ = Mounting surface
- Ⓟ = Space for air circulation

MC 366

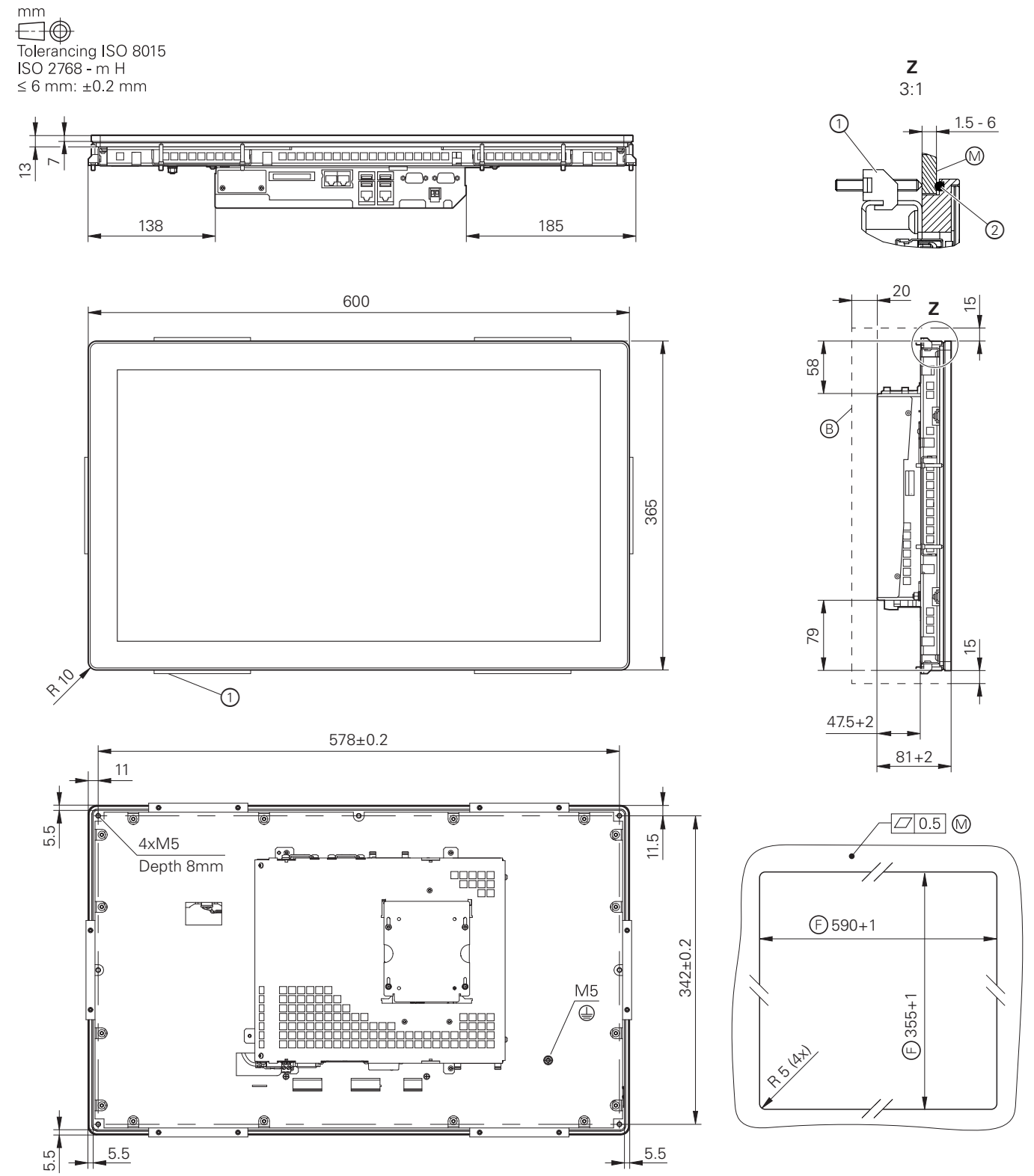

- ⊕ = Front panel opening
- Ⓜ = Mounting surface
- Ⓟ = Space for air circulation
- 1 = Holding clamp (6x), each with two M4 setscrews with hexagon socket and cone point
- 2 = O-ring cord, EPDM

Operating panel, monitor, and keyboard

BF 360, ITC 362

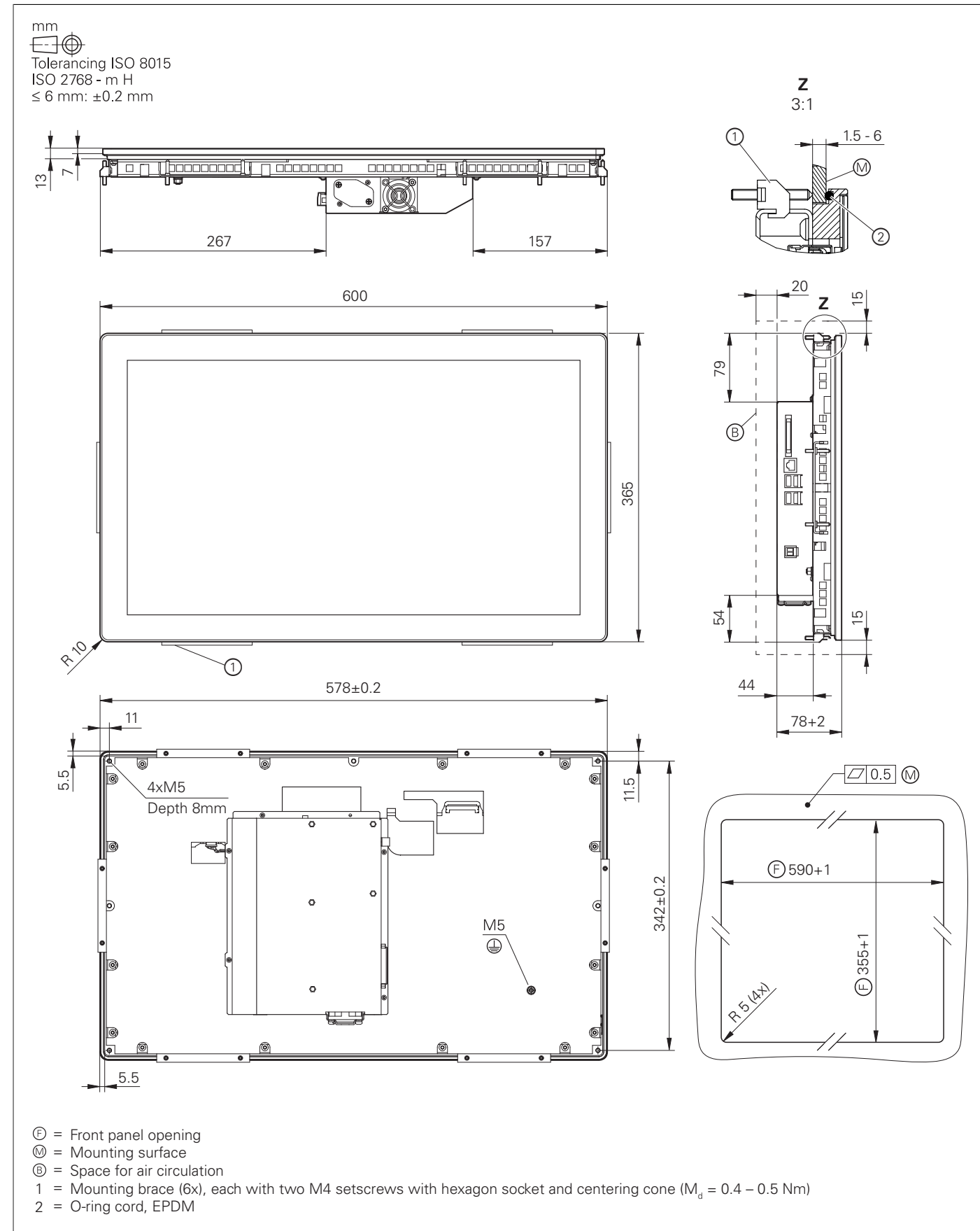

ITC 860

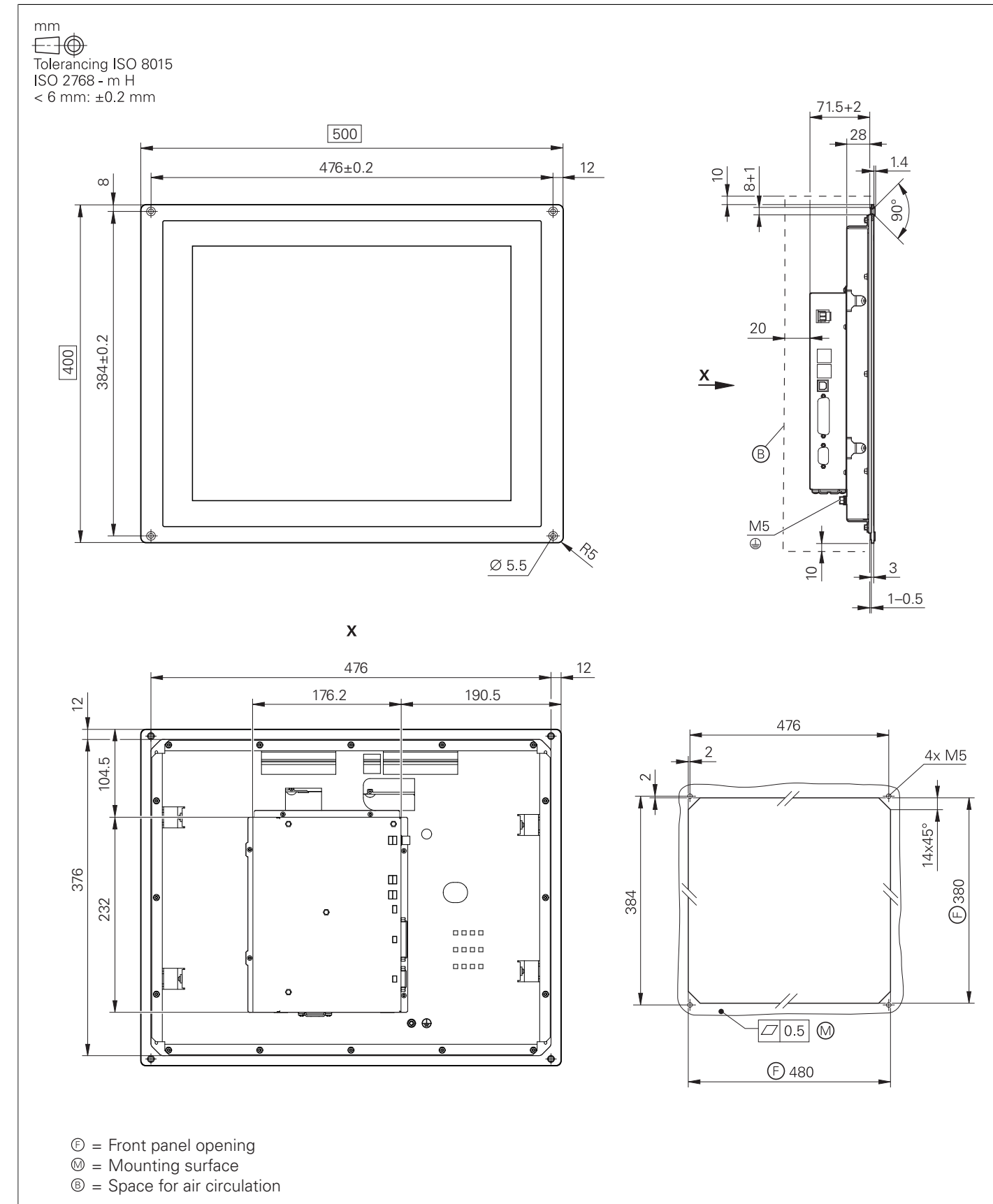

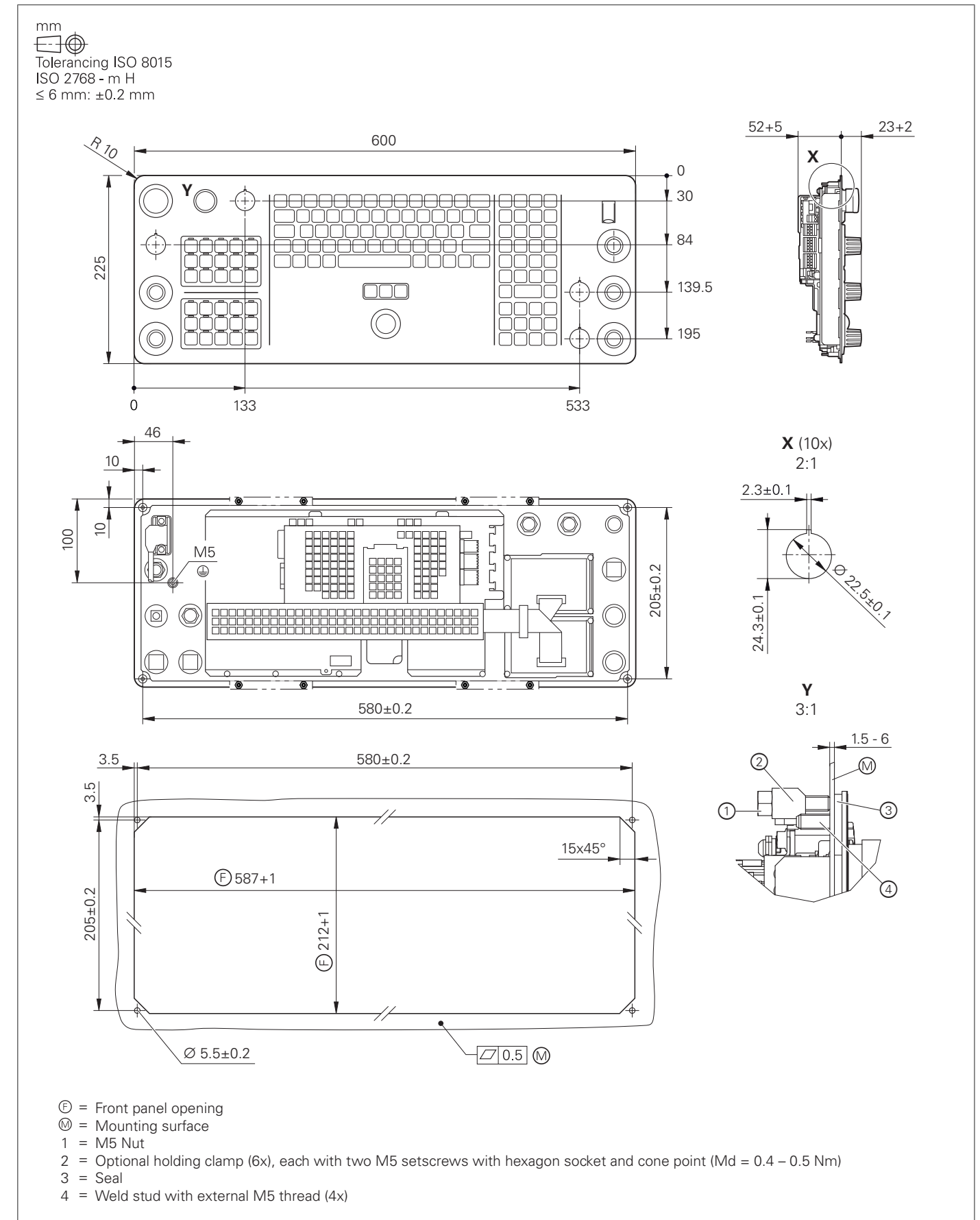
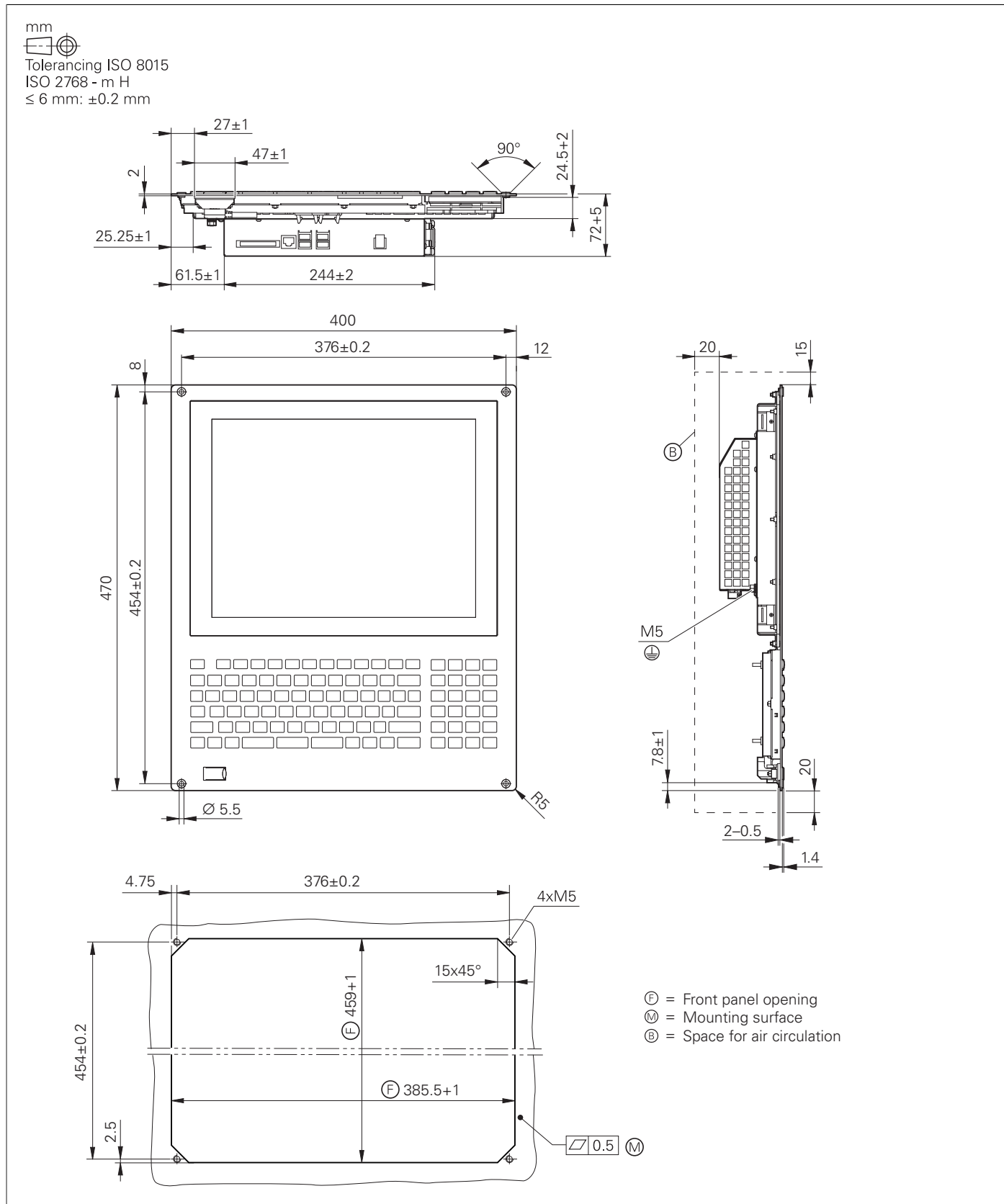

TE 725T, TE 725T FS

mm

 Tolerancing ISO 8015
 ISO 2768 - m H
 < 6 mm: ±0.2 mm

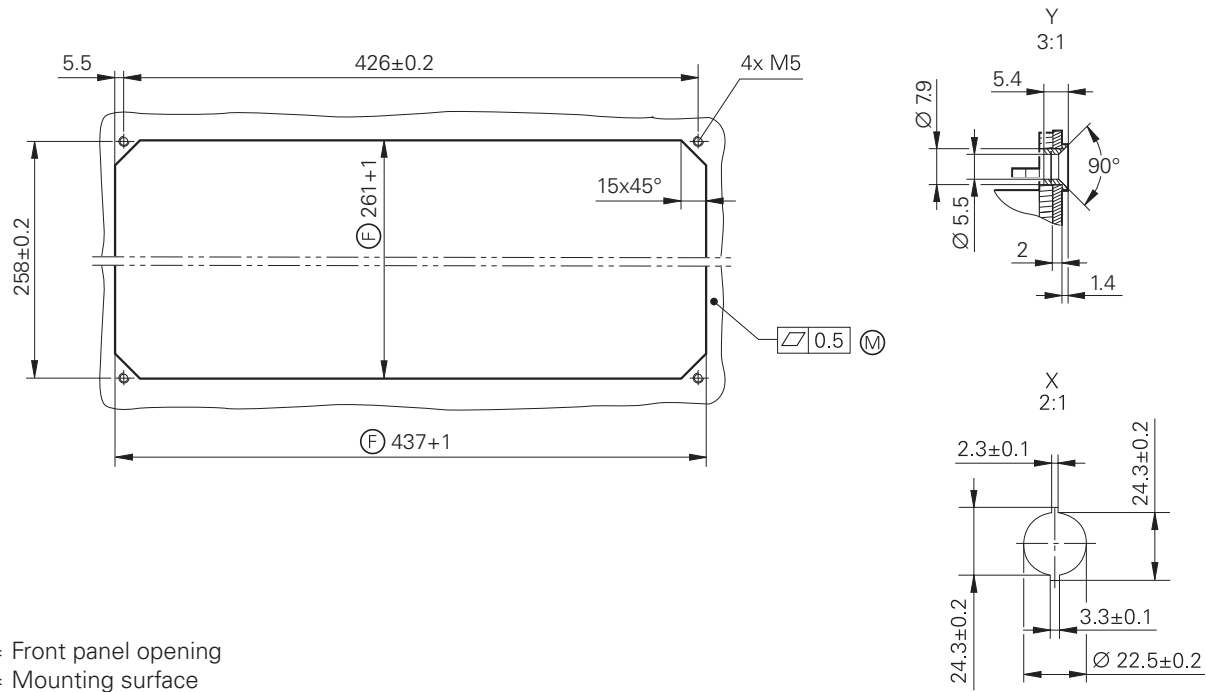
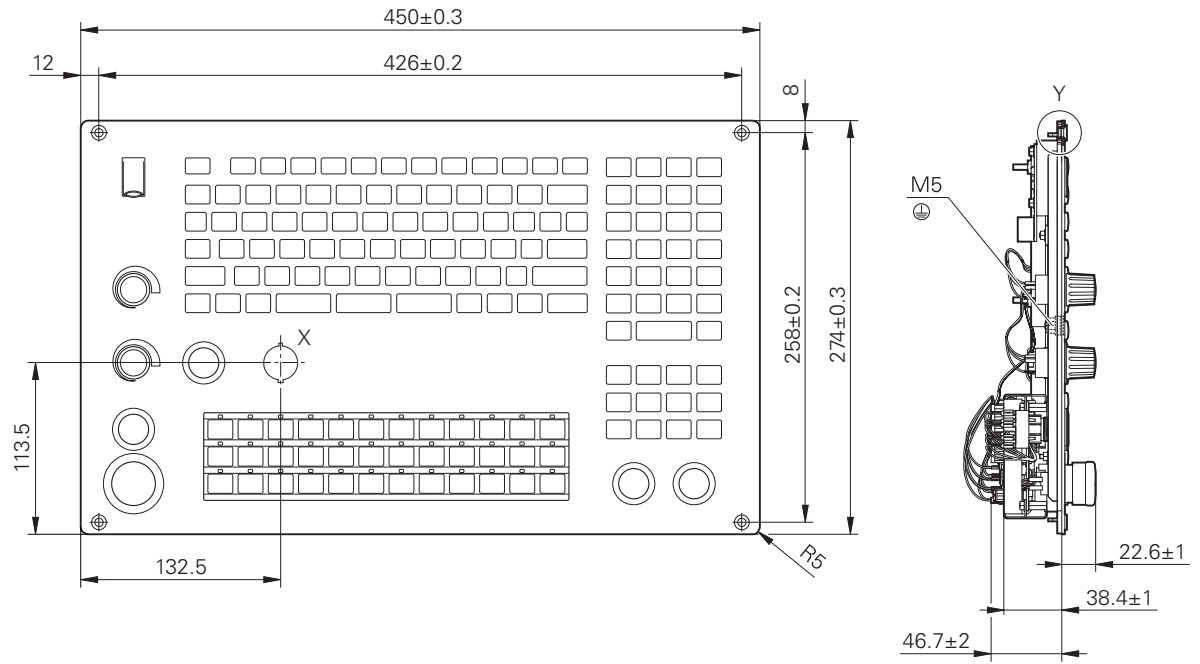

⊕ = Front panel opening
 ⊙ = Mounting surface

PLB 6001, PLB 600x FS

mm

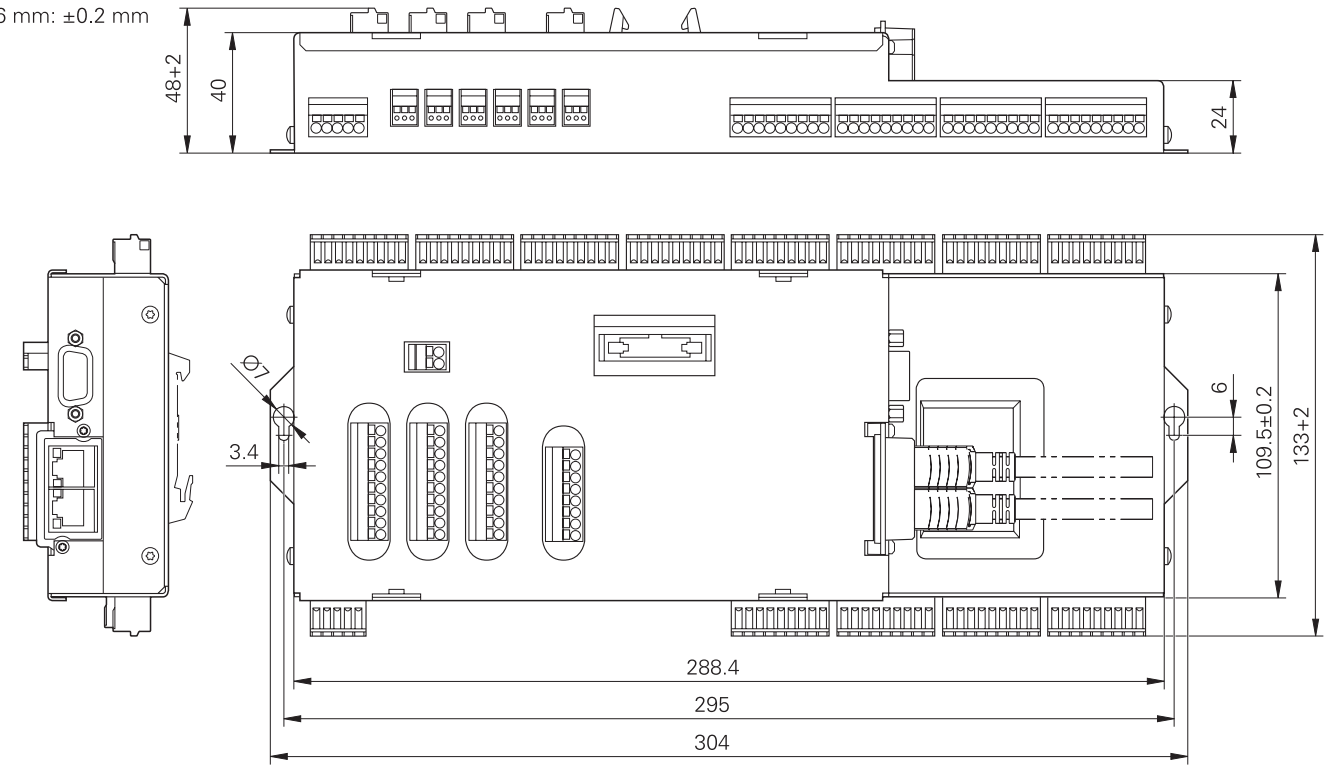
 Tolerancing ISO 8015
 ISO 2768 - m H
 < 6 mm: ±0.2 mm

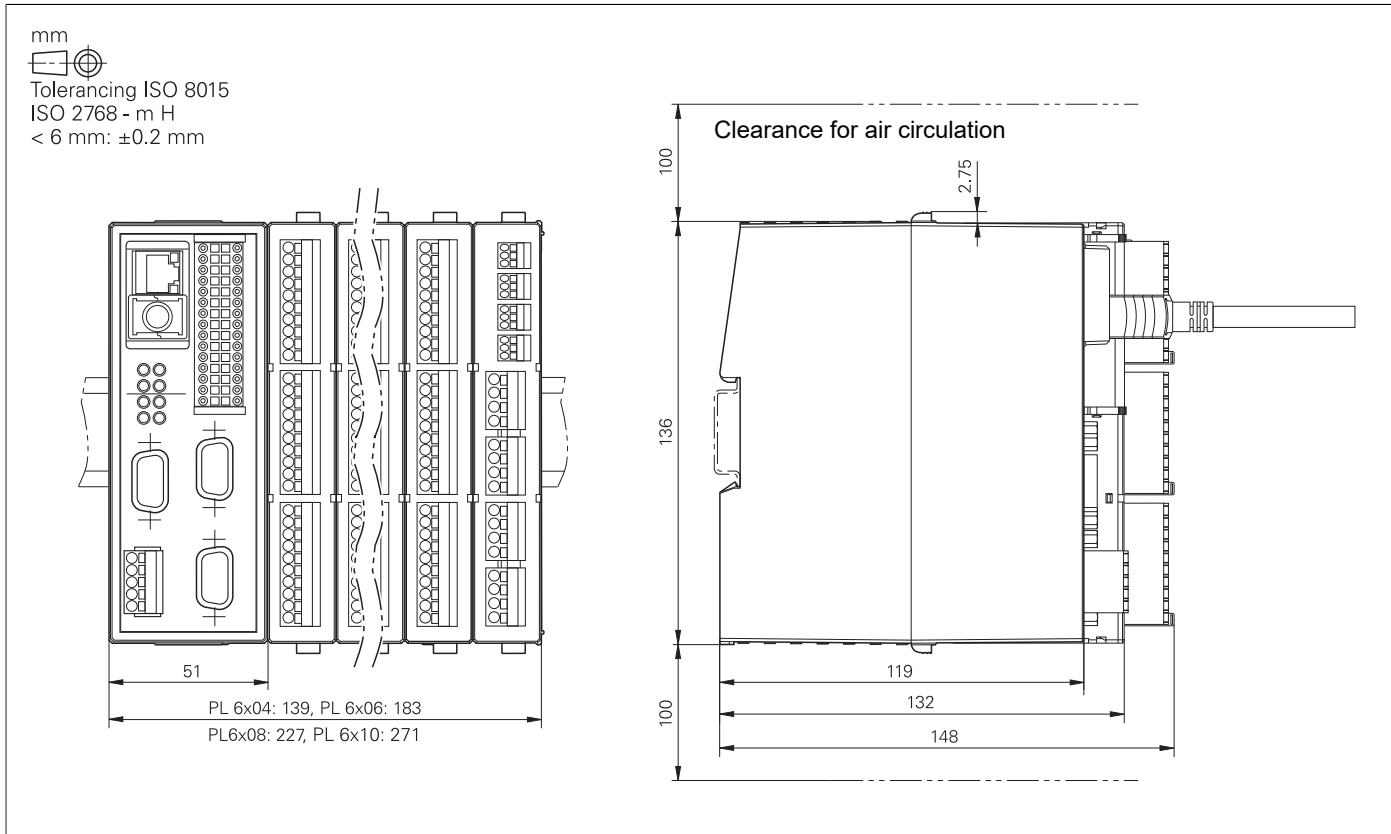

PLC inputs and outputs

PL 6000 (PLB 62xx, PLB 61xx)



Electronic handwheels

HR 510, HR 510 FS

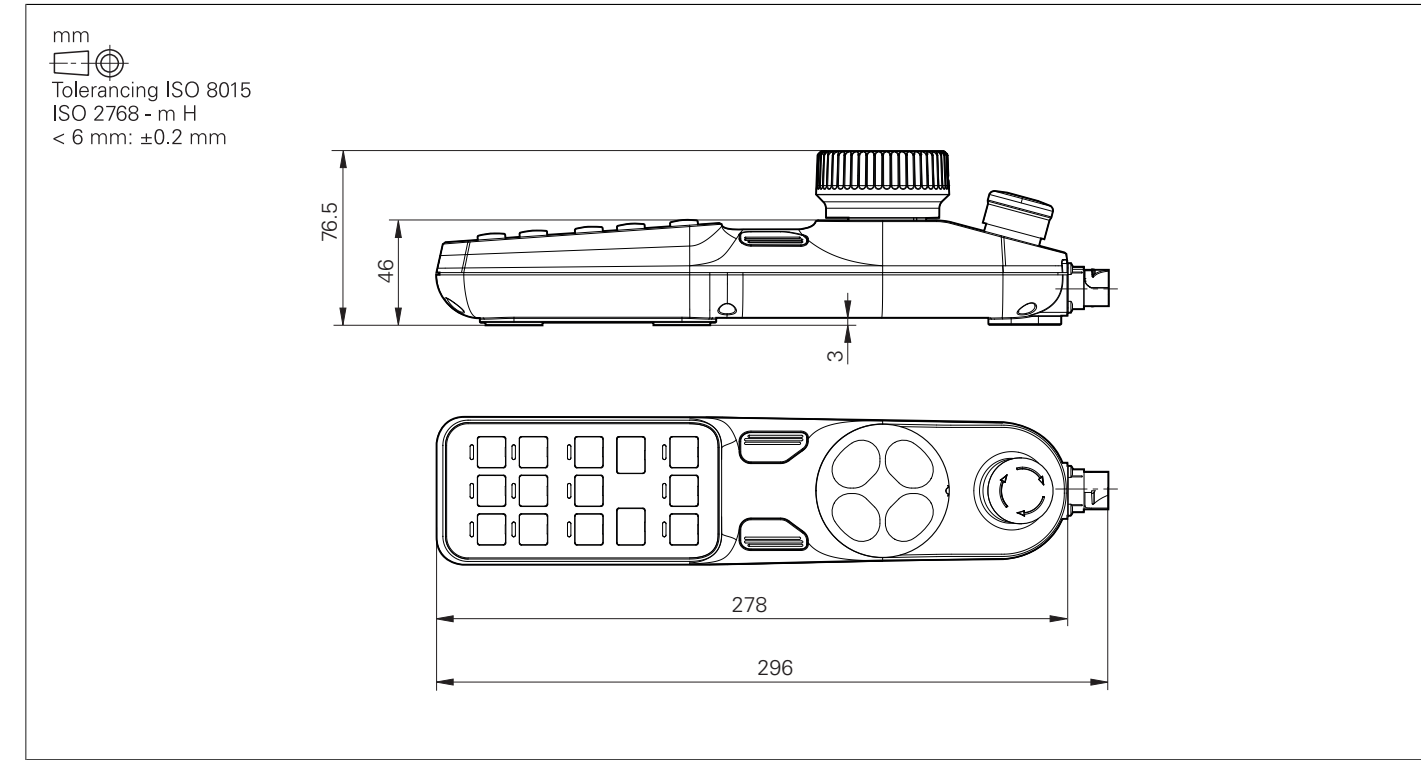

HR 520, HR 520 FS

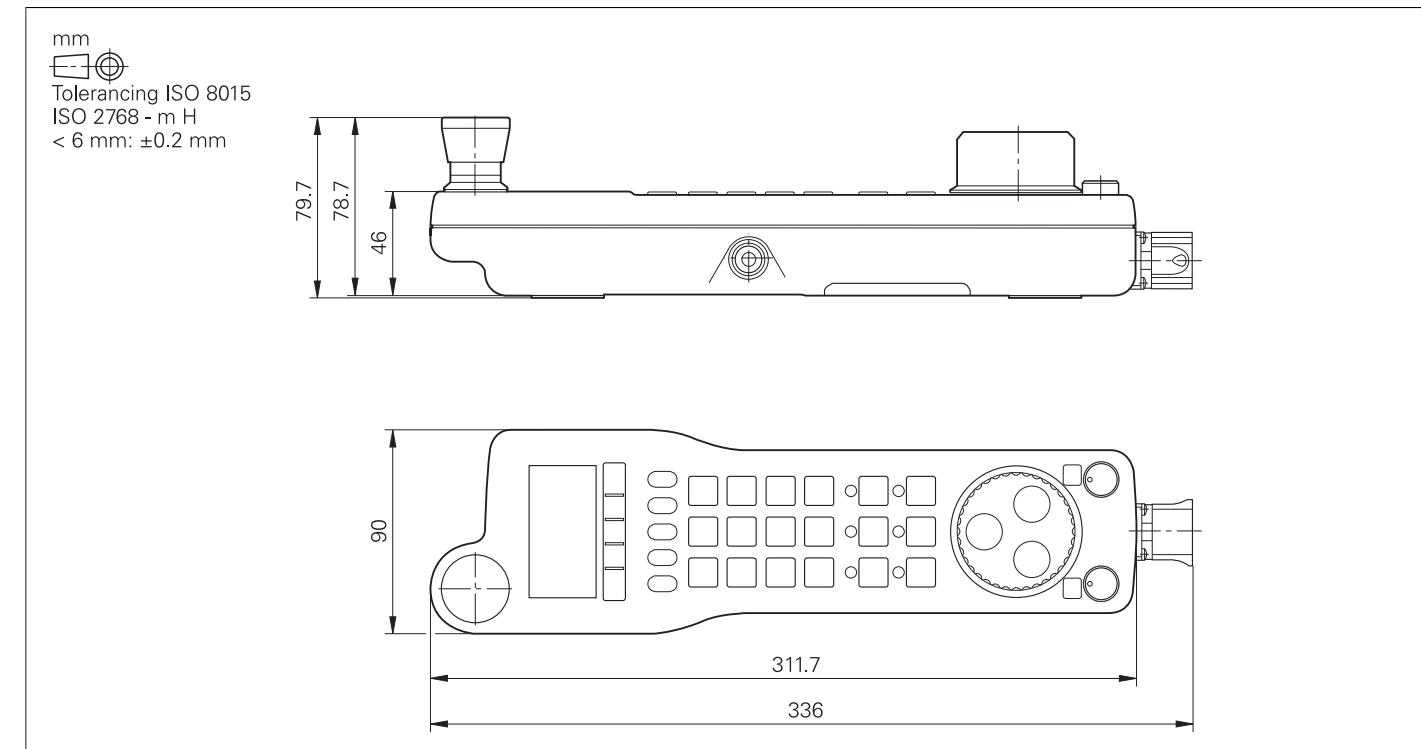

Holder for HR 520, HR 520 FS

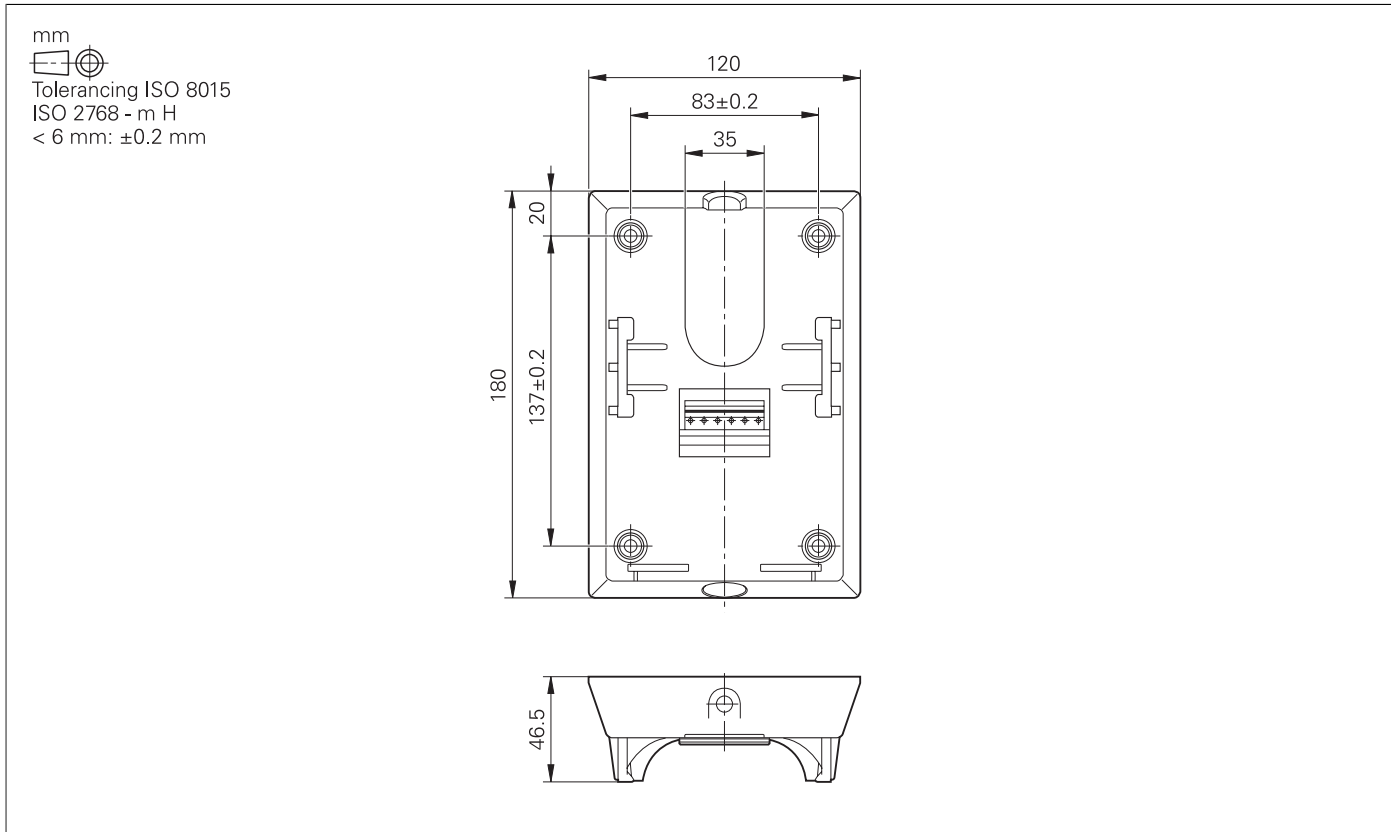

HRA 551 FS

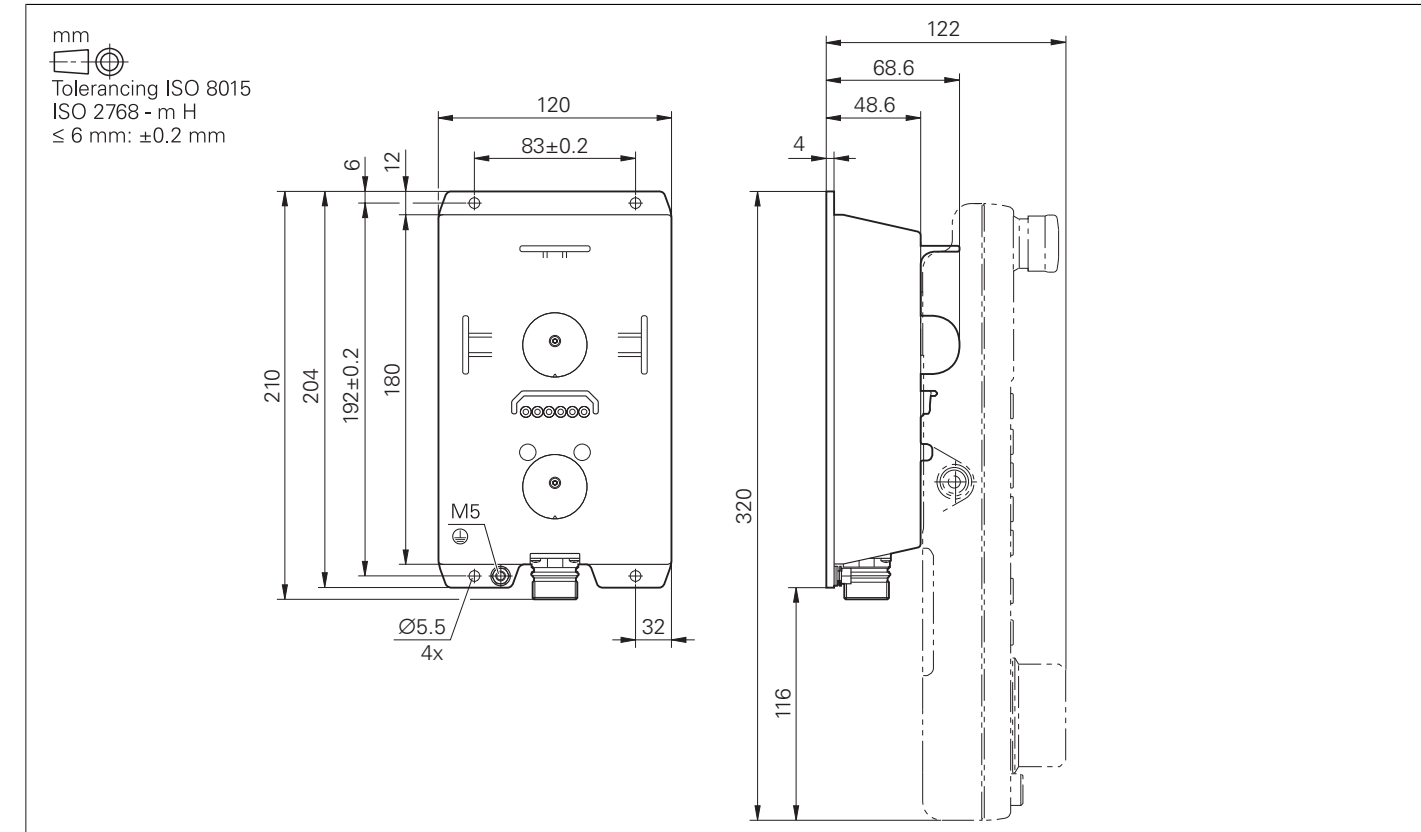

HR 550 FS

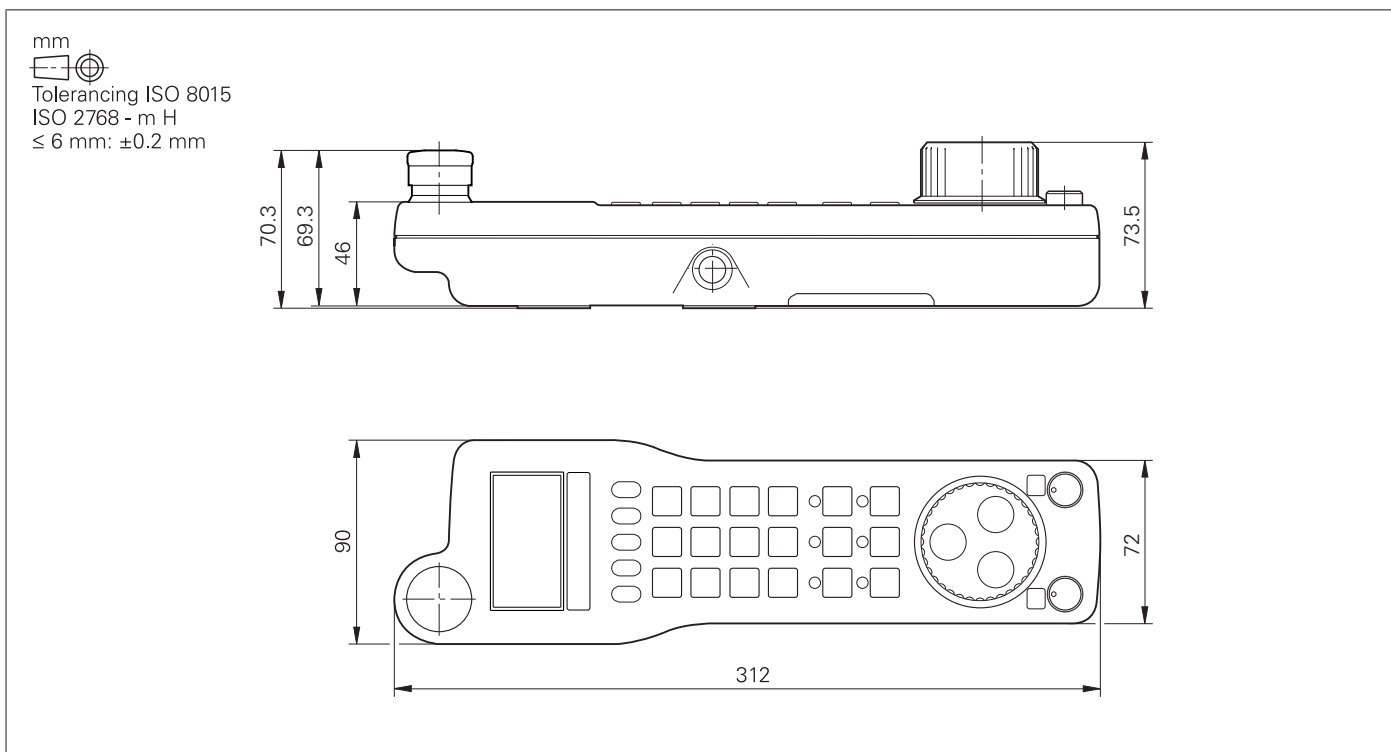

HR 130

mm

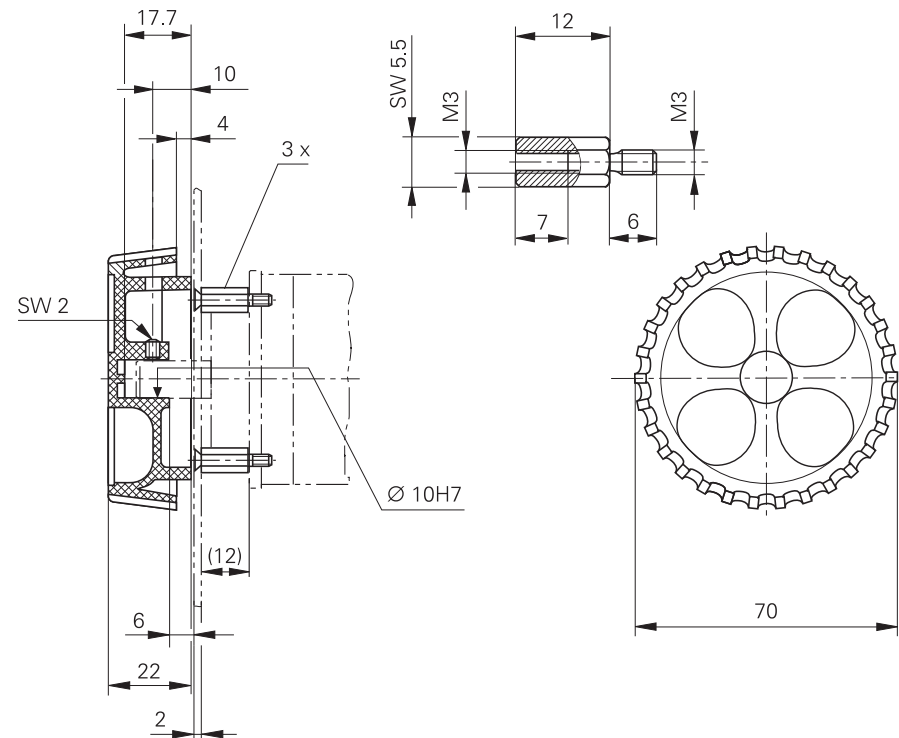
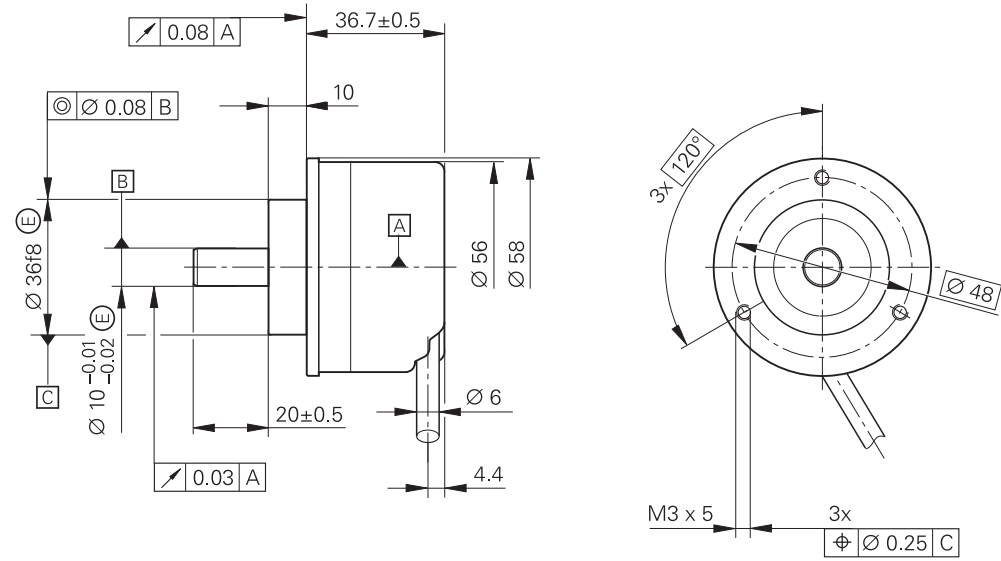
 Tolerancing ISO 8015
 ISO 2768 - m H
 < 6 mm: ±0.2 mm

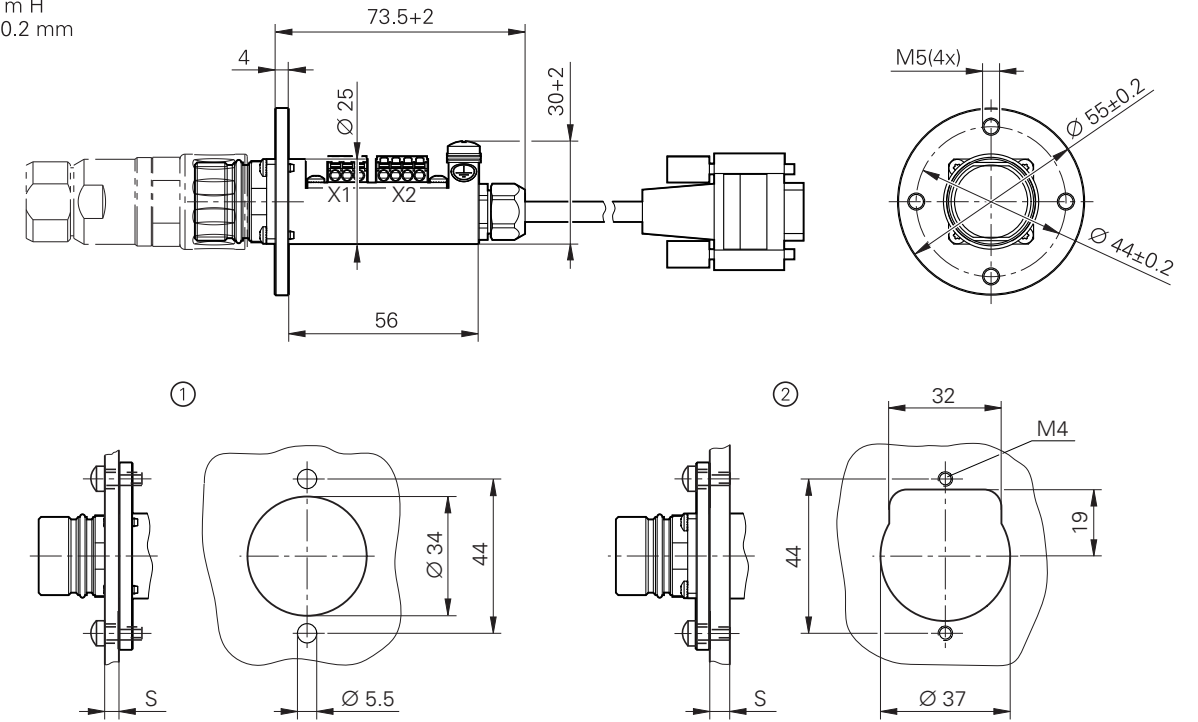

Adapter cable for handwheels (straight)

mm

 Tolerancing ISO 8015
 ISO 2768 - m H
 < 6 mm: ±0.2 mm



- ① Mounting opening up to wall thickness $S = 4$
- ② Mounting opening for wall thickness $S = 4$ or more

HR/HRA adapter cable to MC (straight connector)

Interface accessories

Adapter cable for handwheels (angled)

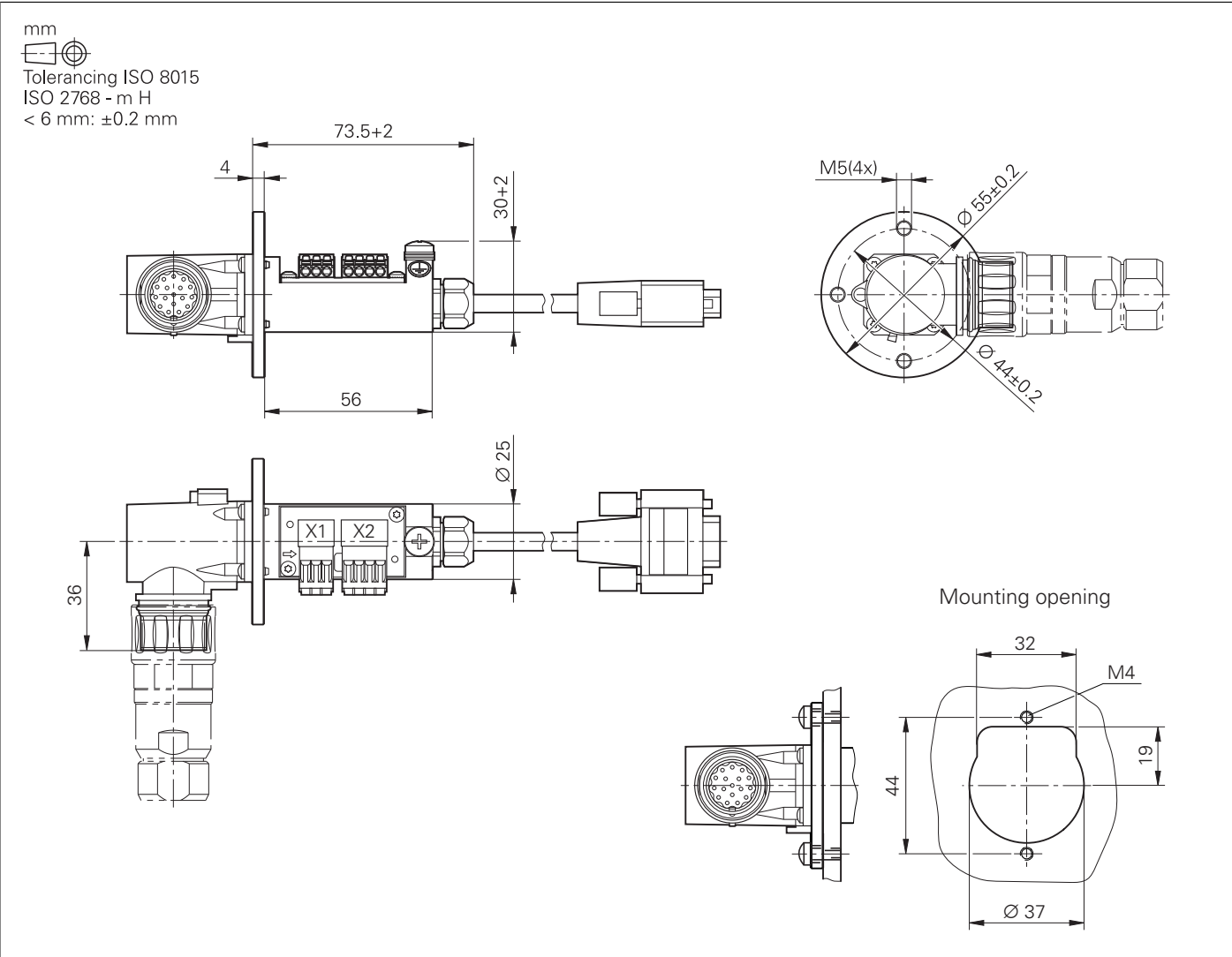

Adapter cable for HR/HRA to MC (angled connector)

Line-drop compensator for encoders with EnDat interface

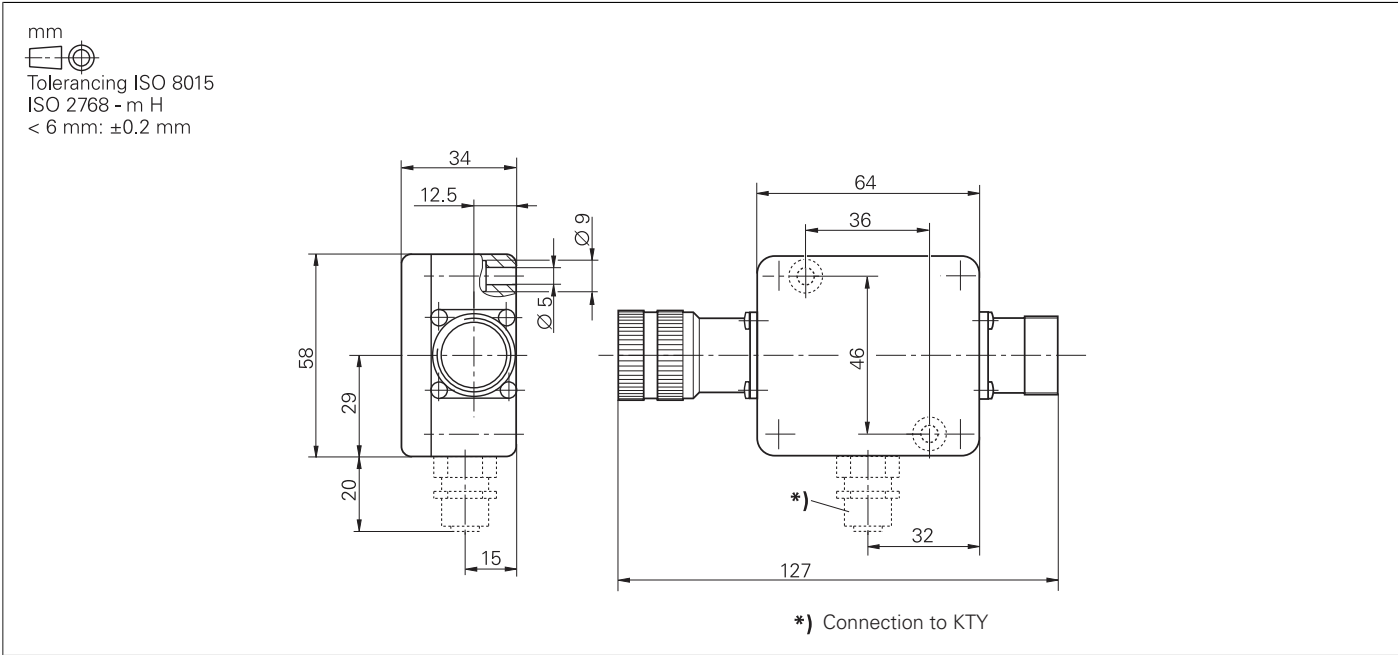

USB extension cable with hubs

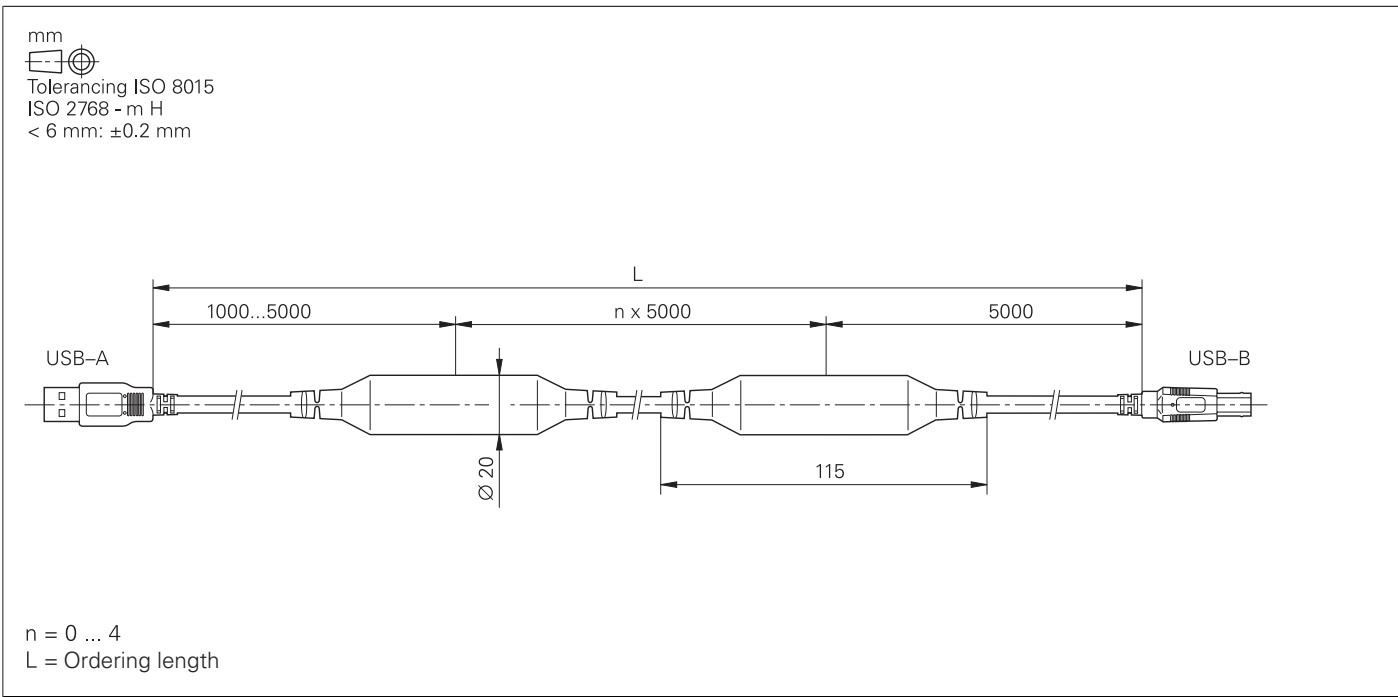

KTY adapter connector

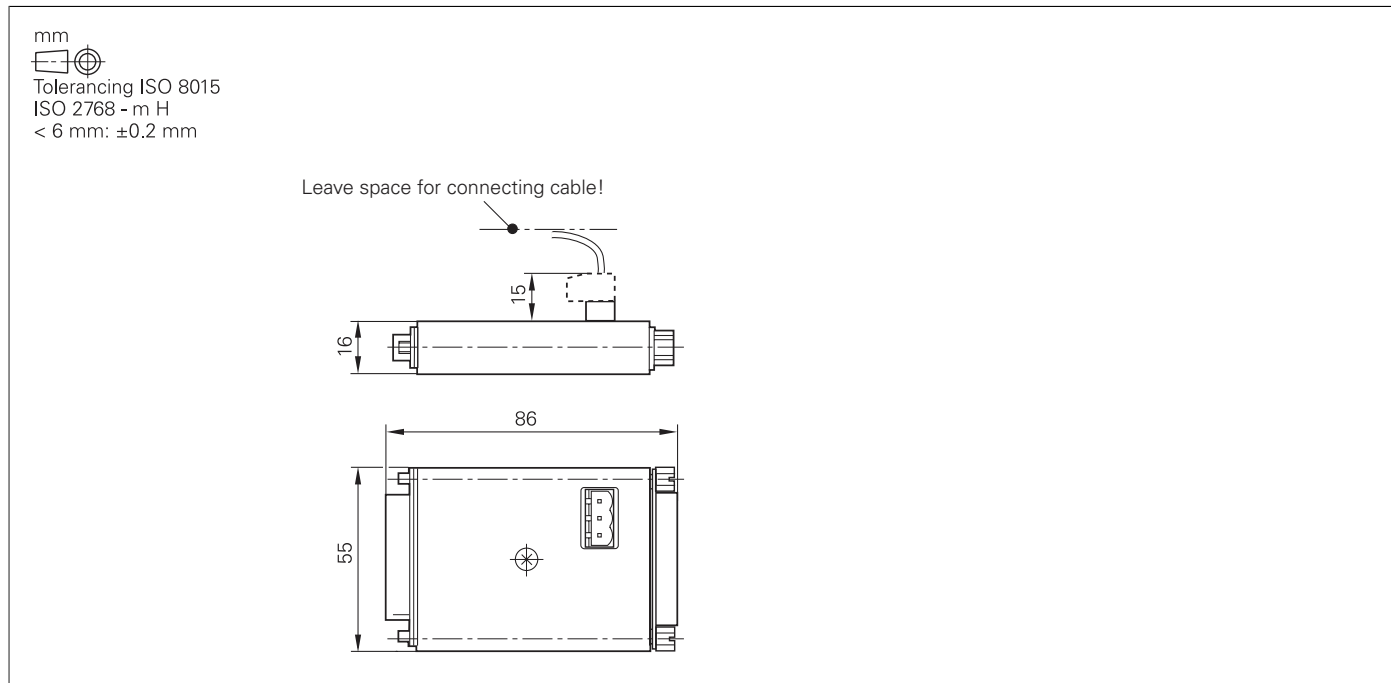

General information

Documentation

Technical documentation	Technical Manuals (PDF format on HESIS-Web including Filebase)	
	<ul style="list-style-type: none"> • CNC PILOT 640 ID 1090006 • PNC 610 ID 1191125 • Inverter Systems for Gen 3 Drives ID 1252650 • Functional Safety (FS) ID 749363 • Functional Safety (FS) Supplement to the Technical Manual ID 1177599 • Python in HEIDENHAIN Controls ID 757807 • Motors ID 1296230 	
User documentation	User's Manuals	
	<ul style="list-style-type: none"> • CNC PILOT 640 ID 1079662-xx • smart.Turn and DIN (ISO) Programming ID 1118606-xx <p><i>General:</i></p> <ul style="list-style-type: none"> • TNCremo Integrated help • TNCremoPlus Integrated help • IOconfig Integrated help • PLCdesign Integrated help 	
Other documentation	Brochures	
	<ul style="list-style-type: none"> • CNC PILOT 640 ID 895949-xx • Functions of the CNC PILOT 640 ID 1224137-xx • Touch Probes ID 1113984-xx • Inverter Systems for Gen 3 Drives ID 1303180-xx • Motors ID 208893-xx • RemoTools SDK virtualTNC ID 628968-xx • Programming Station for Lathe Controls ID 826688-xx 	
	Booklets	
	<ul style="list-style-type: none"> • HR 550 FS ID 636227-xx 	
Programming station for lathe controls	<p>The DataPilot CP 640, MP 620 is the programming station for the CNC PILOT 640 and MANUALplus 620 lathe controls:</p> <ul style="list-style-type: none"> • Full version, single-station license (ID 1230536-02) • Full version, network license for 14 training stations (ID 1230537-02) • Full version, network license for 20 training stations (ID 1230538-02) 	
Note:	<p>To find the programming station software, drivers for the software security module (USB dongle) and the related documentation, visit the Downloads area of the HEIDENHAIN website.</p> <p>Without the software security module (USB dongle), the programming station software runs as a demo version (with limitations).</p> <p>For more information, please ask your contact person at HEIDENHAIN.</p>	

Safety parameters

The safety parameters must be calculated for every machine (e.g., as per EN ISO 13849-1), with the assemblies being used taken into account. HEIDENHAIN provides relevant documents containing the failure rates.

Registered customers will find the safety parameters for the Gen 3 drives with external and built-in functional safety (FS) in the HESIS including Filebase.

Non-registered customers will receive the documents upon request from their HEIDENHAIN contact persons. Documents for older inverter systems are available only upon request.

The following documents can be downloaded via the Filebase:

Document	ID
System Description and Failure Rates – Supplement to the Technical Manual – Gen 3 Drives – PFH values for controls	1312624
System Description and Failure Rates – Supplement to the Technical Manual – MTTF values for emergency stop buttons and permissive buttons	815683
System Description and Failure Rates – Supplement to the Technical Manual – Failure rates of HEIDENHAIN motors	1029960

Basic circuit diagram

More information on basic circuit diagrams can be requested from your HEIDENHAIN contact person.

Service and training

Technical support

HEIDENHAIN offers technical support to the machine manufacturer in order to optimize the interfacing of the control to the machine, including on-site support.

Exchange control

In the event of a malfunction, HEIDENHAIN guarantees the timely shipment of an exchange control (usually within 24 hours in Europe).

Helpline

Our customer service technicians are available for questions regarding adaption or in the event of malfunctions:

NC support

(initial configuration/optimization, field service/troubleshooting)

+49 8669 31-3101

E-mail: service.nc-support@heidenhain.de

PLC/Python programming

Functional safety (FS)

+49 8669 31-3102

E-mail: service.plc@heidenhain.de

NC/Cycle programming and kinematics

+49 8669 31-3103

E-mail: service.nc-pgm@heidenhain.de

Encoders and machine calibration

+49 8669 31-3104

E-mail: service.ms-support@heidenhain.de

Application programming

+49 8669 31-3106

E-mail: service.app@heidenhain.de

If you have questions about repairs, spare parts, or exchange units, please contact our Service department:

Customer service, Germany

+49 8669 31-3121

E-mail: service.order@heidenhain.de

Customer service, international

+49 8669 31-3123

E-mail: service.order@heidenhain.de

Machine calibration

On request, HEIDENHAIN engineers will calibrate your machine's geometry (e.g., with a KGM grid encoder).

Technical training courses

HEIDENHAIN provides technical customer training in the following subjects:

- NC programming
- PLC programming
- TNC optimization
- TNC servicing
- Encoder servicing
- Customized training

For more information on dates or registration:

Technical training courses in Germany	+49 8669 31-3049 E-mail: mtt@heidenhain.de
Technical training courses outside of Germany	www.heidenhain.com EN ► Service & Support ► Technical training

Other HEIDENHAIN controls

Examples

TNC 320

- Compact contouring control for **milling, drilling, and boring machines**
- Axes: 6 control loops, of which up to 2 can be configured as spindles
- Analog nominal-value interface to the drives ($\pm 10\text{ V}$)
- Compact design: screen, keyboard, and main computer all in one unit
- Dimensions: 400 mm x 470 mm x 105 mm
- Integrated 15-inch screen
- Storage medium for NC programs: CompactFlash memory card
- Programming in HEIDENHAIN Klartext format
- Standard milling, drilling, and boring cycles
- Touch probe cycles
- Short block processing time

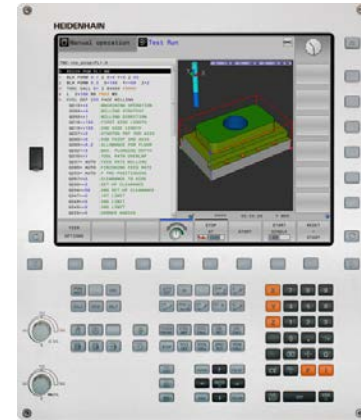

TNC 620

Information:

TNC 620 brochure

- Compact contouring control for **milling, drilling, and boring machines**
- Axes: 8 control loops, of which up to 2 can be configured as spindles
- For operation with HEIDENHAIN inverter systems and ideally HEIDENHAIN motors
- Uniformly digital with HSCI interface and EnDat interface
- Compact size
- CompactFlash memory card
- Programming in HEIDENHAIN Klartext format or G-code (ISO)
- Standard milling, drilling, and boring cycles
- Touch probe cycles
- Short block processing time (1.5 ms)

19-inch screen (portrait) design

- Monitor, keyboard, and main computer in one unit (MC 8410)
- Integration of the keyboard in the lower screen area
- Multi-touch operation

15-inch screen (landscape) design

- Monitor and main computer in one unit (MC 8420)
- Separate keyboard unit
- Multi-touch operation



TNC 640

Information:

TNC 640 brochure

- Contouring control for **milling machines, milling-turning machines, and machining centers**
- Axes: up to 24 control loops, of which up to 4 can be configured as spindles
- For operation with HEIDENHAIN inverter systems and ideally with HEIDENHAIN motors
- Uniformly digital with HSCI interface and EnDat interface
- Version with touchscreen for multi-touch operation
- Solid state disk (SSDR)
- Programming in HEIDENHAIN Klartext or G-code (ISO)
- Comprehensive cycle package for milling and turning operations
- Constant surface speed for turning operations
- Tool radius compensation
- Touch probe cycles
- Free contour programming (FK)
- Short block processing time ($< 0.5\text{ ms}$)



TNC7

- Contouring control for **milling machines, milling-turning machines, and machining centers**
- Axes: up to 24 control loops (22 control loops with functional safety (FS)), of which up to 4 can be configured as spindles
- For operation with HEIDENHAIN inverter systems and ideally with HEIDENHAIN motors
- Uniformly digital with HSCI interface and EnDat interface
- Intuitive multi-touch operational design
- Leading-edge functions combined with the familiarity of HEIDENHAIN Klartext: graphical programming allows beginners and experts alike to rapidly program complex workpieces
- Graphically supported alignment of workholding equipment
- Integrated process monitoring
- New, intuitive machine setup with smart probing functions
- Easy operating solutions for everyday production tasks, including complete integration of program testing with high-resolution simulation of the machining process in the Editor operating mode
- Graphical programming
- Short block processing time ($< 0.5\text{ ms}$)



- Compact contouring control for **CNC and cycle lathes**
- Suitable for horizontal and vertical lathes as well as vertical boring and turning mills
- Axes: max. 10 control loops, of which up to 6 can be configured as spindles
- Up to 3 principal axes (X, Z, and Y), B axis, closed-loop spindle and counter spindle, C1/C2 axis, and driven tools
- Up to 3 programmable auxiliary axes (U, V, W) for control of steady rest, tailstock, and counter spindle
- The position of a parallel secondary axis can be shown combined with its principal axis
- Compact design: screen and main computer in one unit
- For operation with HEIDENHAIN inverter systems and ideally with HEIDENHAIN motors
- Fully digital with HSCI interface and EnDat interface
- 15.6-inch multi-touch display with 1366 × 768 pixels
- Integration of the keyboard on the right side of the display
- Storage medium: CFR CompactFlash memory card (CFast)
- Programming of turning, drilling, and milling operations with smart.Turn, according to DIN, or via cycles
- TURN PLUS: automated smart.Turn program generation
- ICP free contour programming for turning and milling contours
- For simple tool holders (multifix), turrets, or magazines
- For simple tool holders (multifix), tool magazines, or tool turrets



Subject index

A	Absolute encoders..... 62	F	Feedforward control..... 63	Main spindle and counter spindle..... 60
	Accessories..... 5		Fieldbus systems..... 26	Master keyword..... 18
	Additional modules..... 26		Functions for the user..... 10	Maximum spindle speed..... 60
	Advanced Dynamic Prediction (ADP).... 66	G		MC 306..... 17, 82
	API DATA..... 71			MC 366..... 17, 85
	Axes..... 57			MC 8420 T..... 17
	Axis clamping..... 64			Module for analog axes..... 26
	Axis feedback control..... 63			Monitoring functions..... 67
B				Mounting and electrical installation..... 81
	Backlash..... 69			Multi-Channel Capability..... 59
	Basic modules..... 23	H		
	B Axis..... 58		HEROS 5..... 56	N
	BF 360..... 22		HR 130..... 29, 96	Nonlinear error..... 69
	BF 360, ITC 362..... 86		HR 510..... 27	O
	Bus diagnosis..... 73		HR 510, HR 510 FS..... 93	
C			HR 510 FS..... 27	Online Monitor..... 71
	Cable overview..... 44		HR 520..... 28	Operating system..... 56
	C-Axis Machining (software option 55).. 60		HR 520, HR 520 FS..... 93	Oscilloscope..... 70
	CMA-H 04-04-00..... 26		HR 520 FS..... 28	
	Combined PROFIBUS DP/PROFINET IO module..... 26		HR 550 FS..... 28, 94	P
	Compensation of torque ripples..... 63		HRA 551 FS..... 28, 95	PAE-H 08-00-01..... 24
	Component Monitoring..... 68		HSCI..... 51	PL 6000..... 23, 92
	Components..... 4		HSCI adapter..... 25	PLA-H 08-04-04..... 24
	ConfigDesign..... 70		HSCI control components..... 16	PLB 6001, PLB 600x FS..... 91
	Connected Machining..... 80		Hysteresis..... 69	PLB 600x..... 25
	Connecting cables..... 29	I		PLB 6104..... 24
	Context-sensitive help..... 68		I/O modules..... 24	PLB 6104 FS..... 24
	Control loop cycle times..... 64		Incremental encoders..... 62	PLB 6106..... 24
	Control systems with external safety... 55		Industrial PCs/ITC..... 30	PLB 6106 FS..... 24
	Control systems with integrated functional safety (FS)..... 53		Initial setup and diagnostic aids..... 70	PLB 6108..... 24
	Counter Spindle (software option 132).. 60		Input resolution..... 6	PLB 6108 FS..... 24
	Crossover Position Filter (CPF)..... 64		Installation elevation..... 81	PLB 6204 EnDat..... 23
D			Integrated inverter..... 63	PLB 6204 FS EnDat..... 23
	Data interfaces..... 78		Integrated PLC..... 74	PLB 6206 EnDat..... 23
	Degrees of protection..... 81		Interfacing to the machine..... 8	PLB 6206 FS EnDat..... 23
	Digital control design..... 51		Inverter system..... 46	PLB 6208 EnDat..... 23
	Digital servo control..... 63		IOconfig..... 24	PLB 6208 FS EnDat..... 23
	Display step..... 6		IPC 306..... 31, 82	PLB 6210 EnDat..... 23
	DNC applications..... 80		IPC 6490..... 83	PLB 6210 FS EnDat..... 23
	Double-Speed Control Loops..... 64		ITC 362..... 30	PLC axes..... 59, 75
	Driven tools..... 61		ITC 855..... 31, 88	PLC basic program..... 76
E			ITC 860..... 87	PLC design..... 75
	EA module for axis release..... 24	J		PLC encryption..... 74
	Electromagnetic compatibility..... 81		Jerk..... 65	PLC inputs/outputs..... 74
	Electronic handwheels..... 27		Jerk limiting..... 65	PLC positioning..... 75
	Encoder inputs..... 62	K		PLC programming..... 74
	EnDat 2.2..... 51		Keycaps..... 39	PLC soft keys..... 75
	Error compensation..... 69	L		PLC window..... 75
	Ethernet..... 78		Linear error..... 69	PLD-H 04-04-00 FS..... 24
	Expansion PL..... 24		Load Adaptive Control (LAC)..... 69	PLD-H 04-08-00 FS..... 24
	Export version..... 16		Load Monitoring..... 68	PLD-H 08-04-00 FS..... 24
			Log..... 71	PLD-H 08-16-00..... 24
			Look-ahead..... 65	PLD-H 16-08-00..... 24
				PNC 610..... 32
				Position-controlled spindle..... 60
				PROFIBUS DP module..... 26
				PROFINET IO module..... 26
				Proper minimum clearance..... 81
				Python OEM Process..... 75
		M		
			Main computer..... 16	

R

Real-Time Coupling Function.....	58
RemoteAccess.....	72
Remote Desktop Manager.....	80
RemoTools SDK.....	80
Reversal spikes.....	69

S

Servo lag.....	63
SIK component.....	18
Sliding friction.....	69
Smoothed jerk.....	65
Snap-on keys.....	34, 36
Software options.....	14
Software tools.....	5
Specifications.....	6
Spindle override.....	60
Spindle Synchronism.....	61
Static friction.....	69
Storage medium.....	18
Synchronized axes.....	58
System PL with EnDat support.....	23

T

Table function.....	71
TE 361 T.....	22, 89
TE 361 T FS.....	22
TE 725 T.....	21, 90
TE 725 T FS.....	21
Thermal expansion.....	69
TNAnalyzer.....	73
TNCdiag.....	70
TNCkeygen.....	18
TNCopt.....	71
TNCremo.....	79
TNCremoPlus.....	79
TNCscope.....	71
TNCtest.....	73
Tool carriers.....	57
Torque Control.....	58
Trace function.....	71
Traverse range.....	57

U

USB.....	78
User administration.....	56
User management.....	13

HEIDENHAIN

Mastering nanometer accuracy



HEIDENHAIN

DR. JOHANNES HEIDENHAIN GmbH
Dr.-Johannes-Heidenhain-Straße 5
83301 Traunreut, Germany
☎ +49 8669 31-0
FAX +49 8669 32-5061
info@heidenhain.de
www.heidenhain.com



HEIDENHAIN
worldwide